

**S 88 K..B**

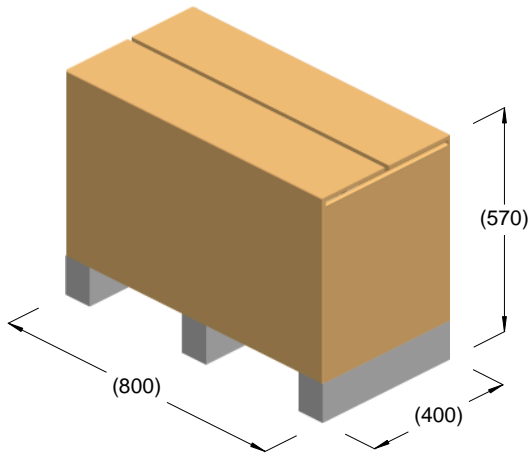

kg = 105  
m<sup>3</sup> = 0.18

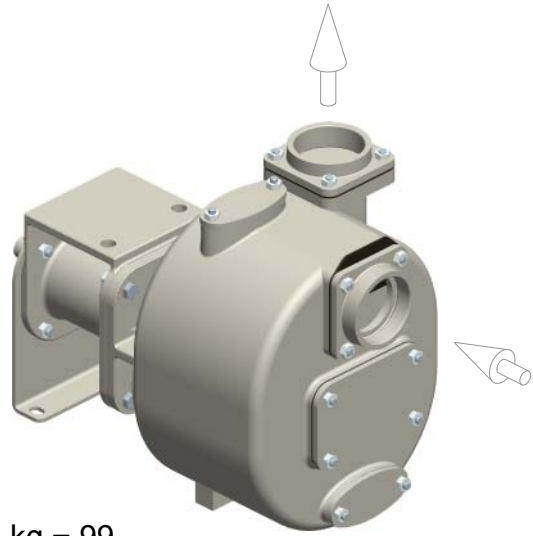

kg = 99

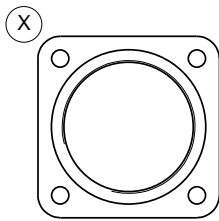
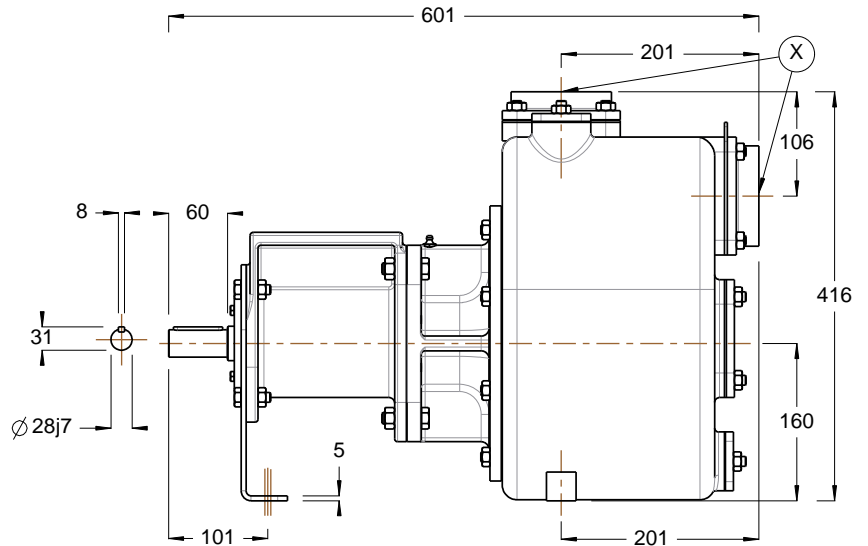
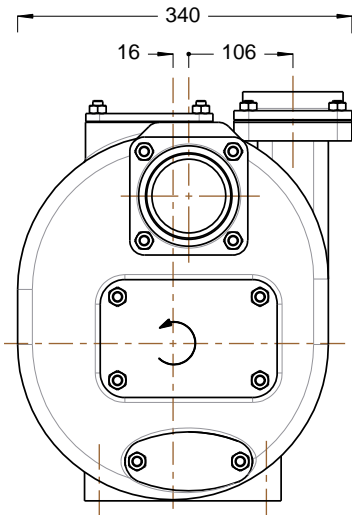

R3" BSP

