

S 88 ...B

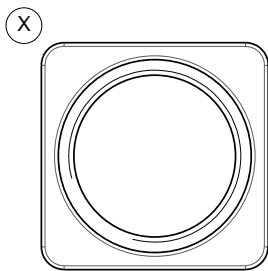

R3" BSP

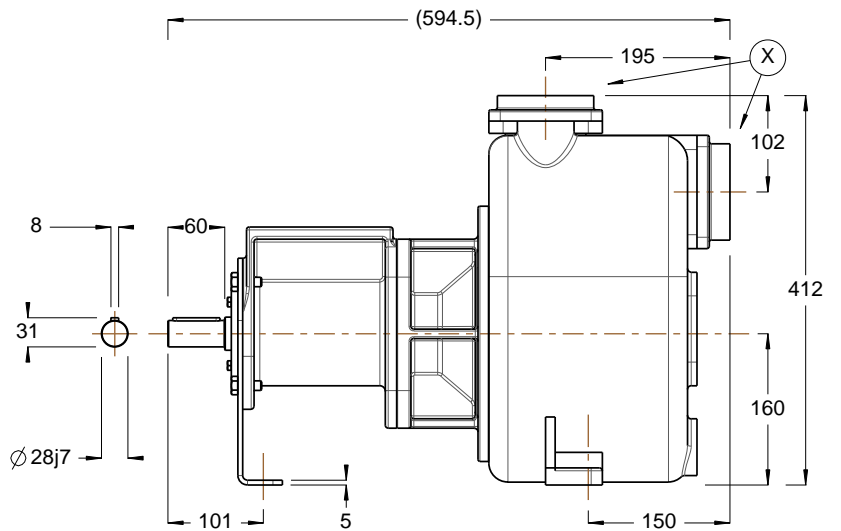
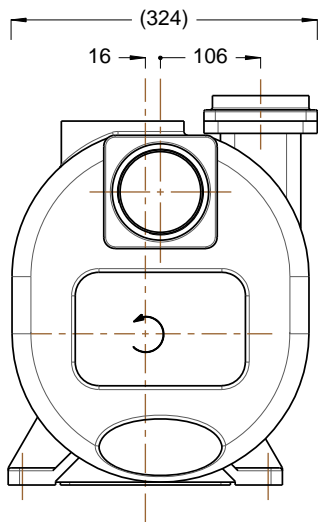
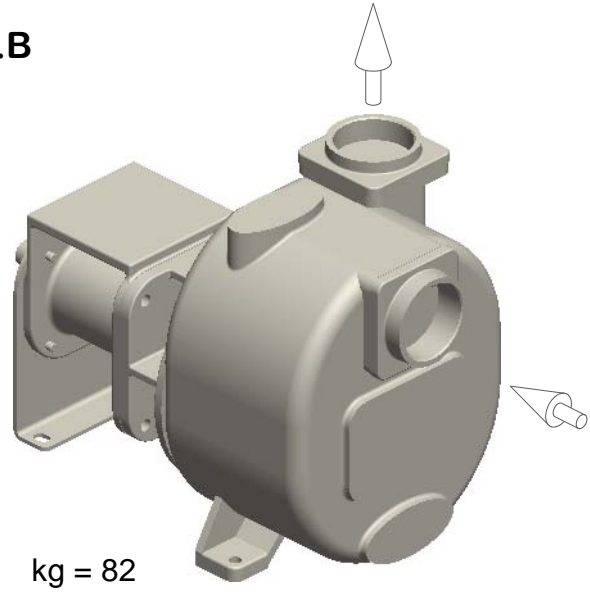
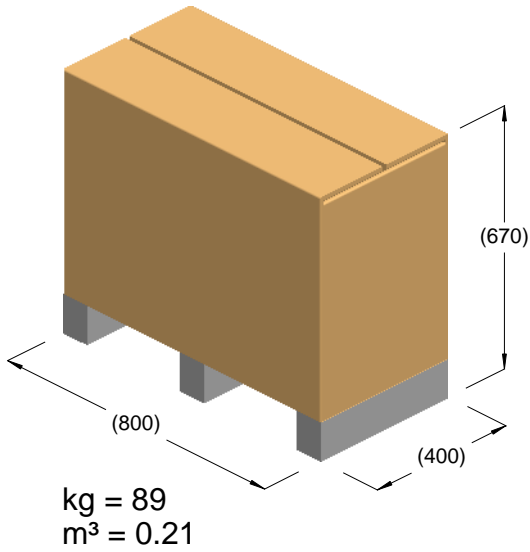