

S 88 ...B+F

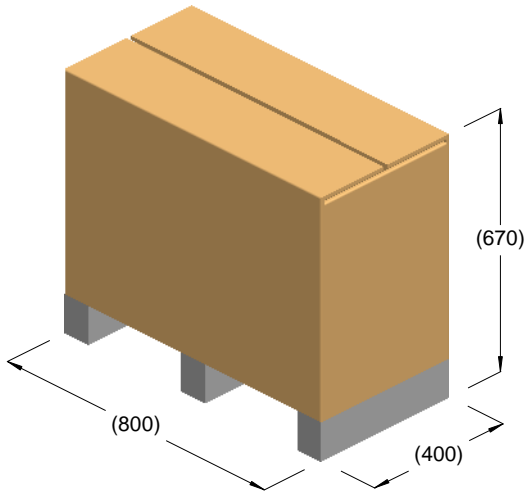

kg = 100
m³ = 0.21

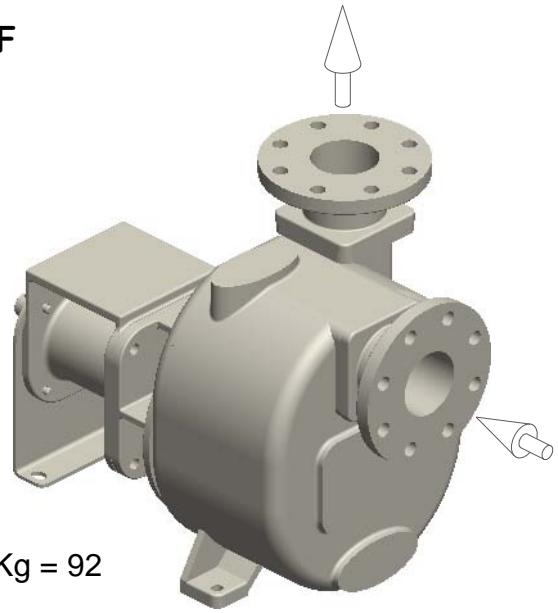

Kg = 92

