

S 85 K..B

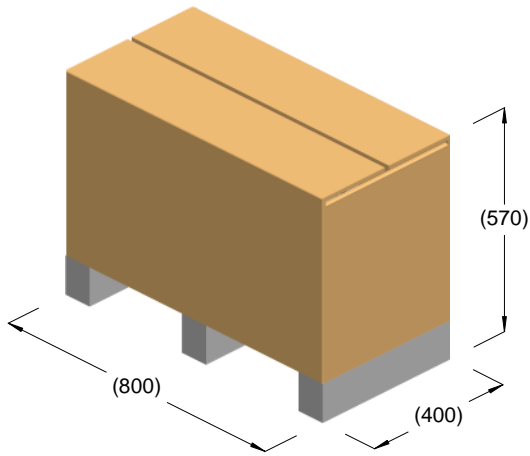

kg = 105
m³ = 0.18

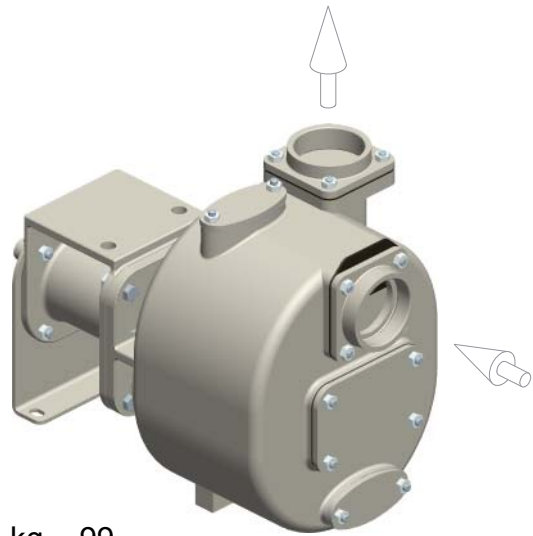

kg = 99

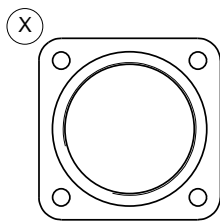
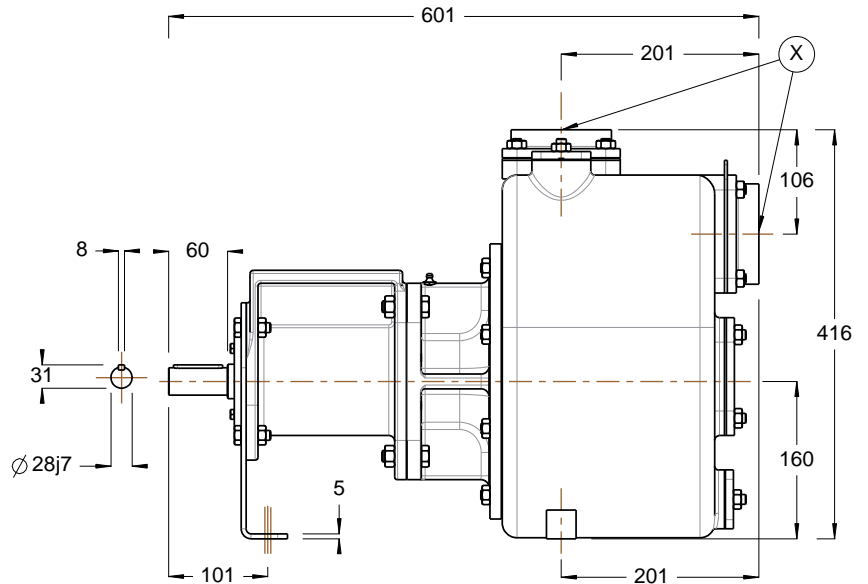
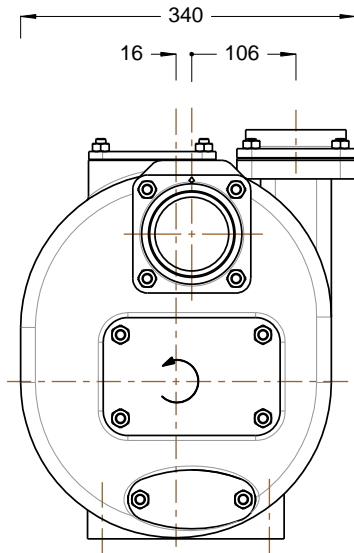

R3" BSP

