

S 85 ...B+F

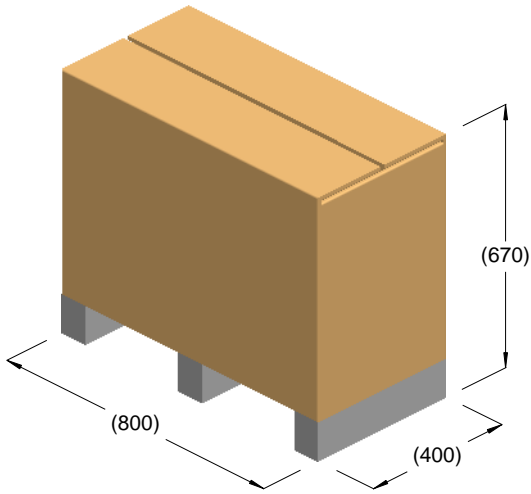

kg = 95
m³ = 0.21

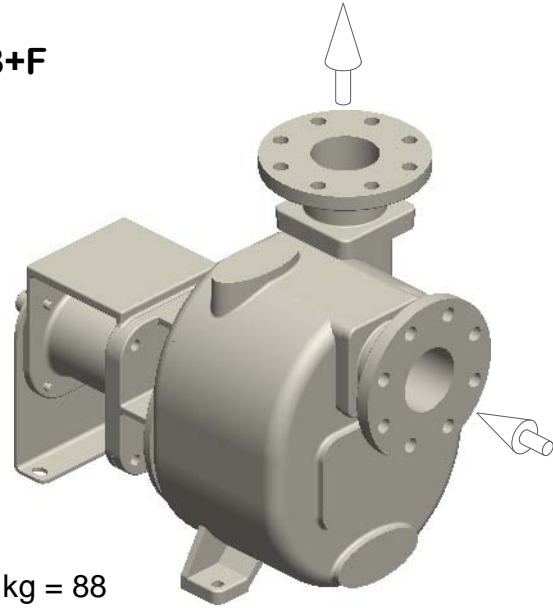

kg = 88

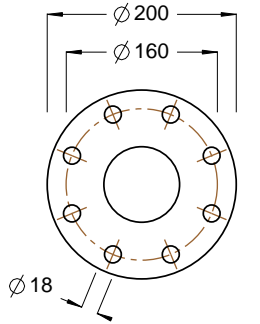
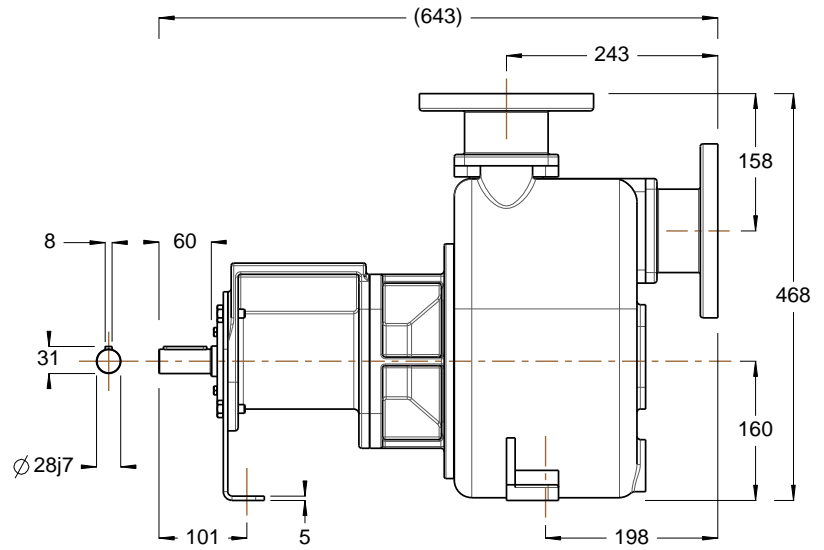
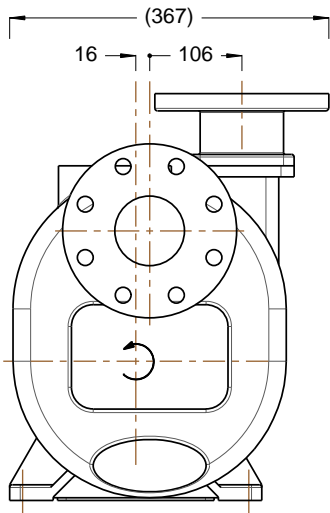

DN80 PN16 / ASA125 3"

