

**S 83 ...B**

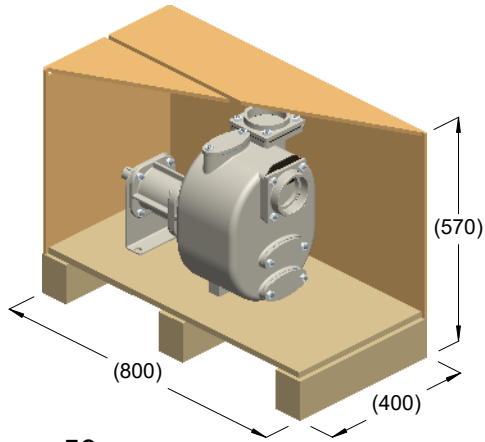

kg = 59  
m<sup>3</sup> = 0.18

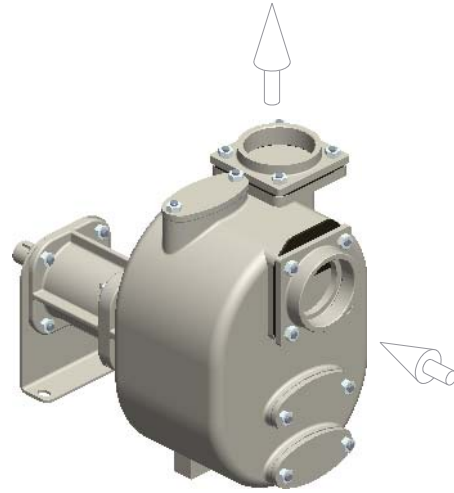

kg = 52

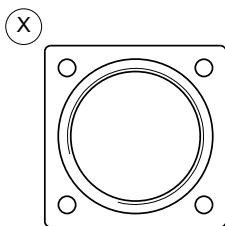
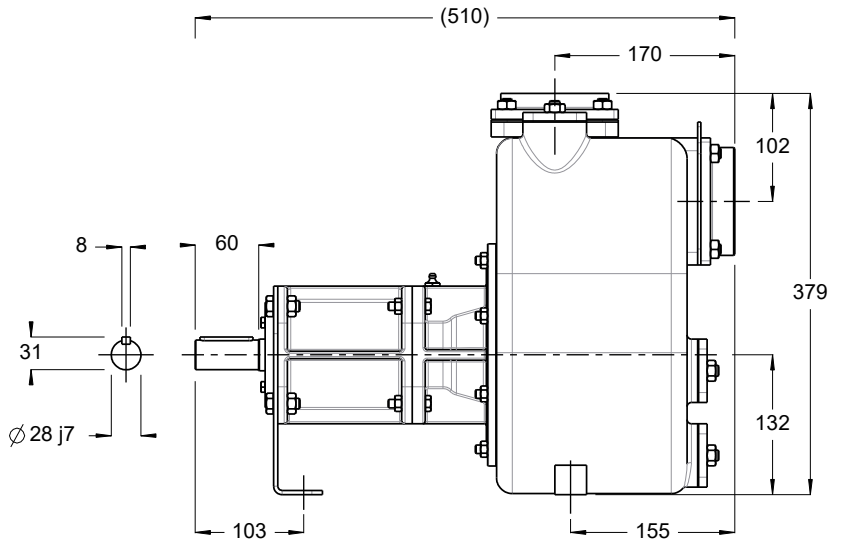
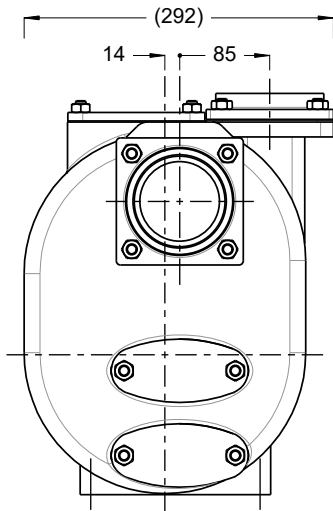

R3" BSP

