

S 83 ...B+F

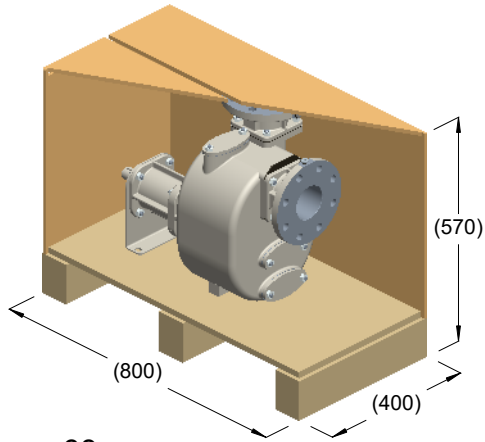

kg = 68
m³ = 0.18

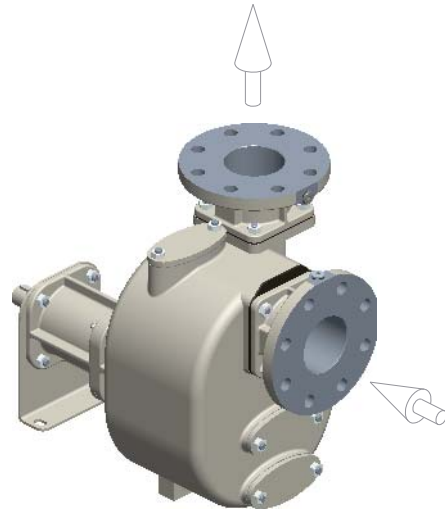

kg = 61

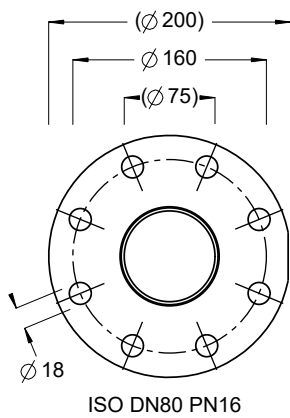
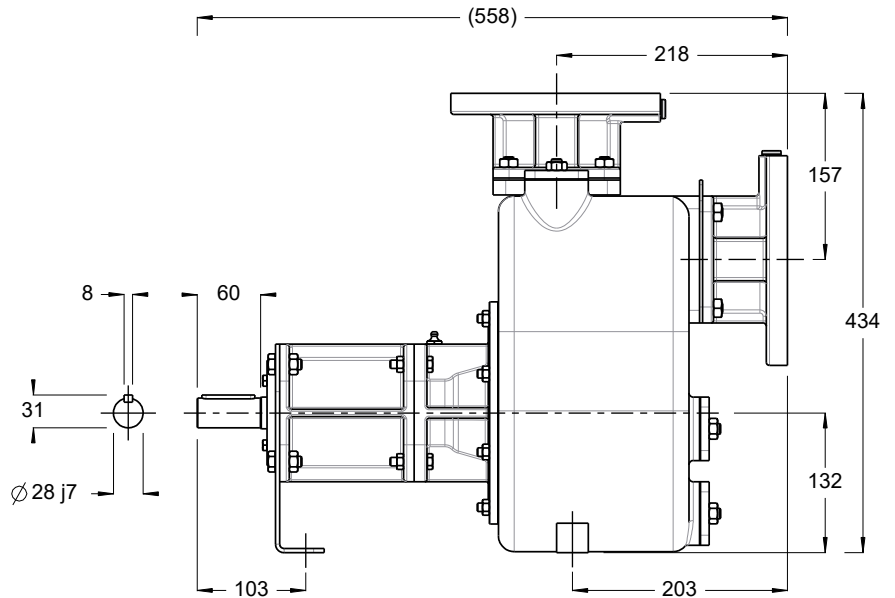
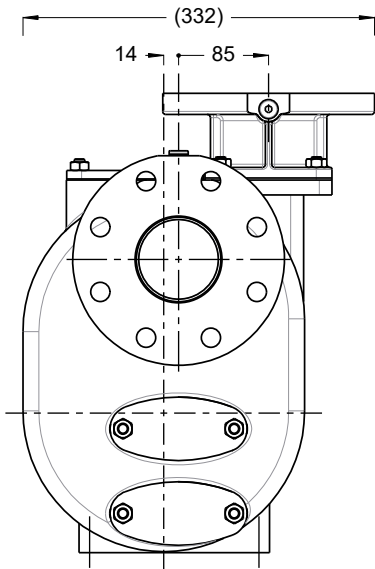

ISO DN80 PN16

