

S 82 K..B

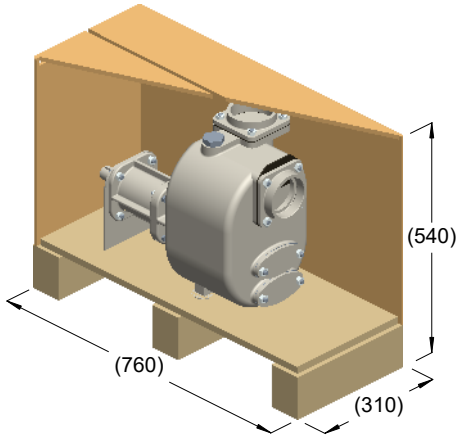

kg = 65
m³ = 0.13

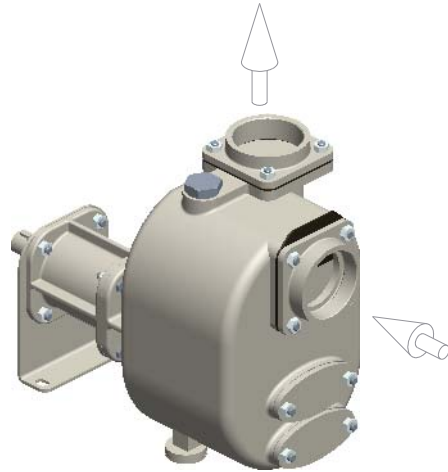

kg = 59

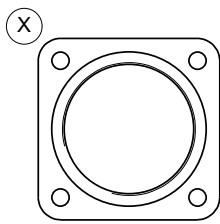
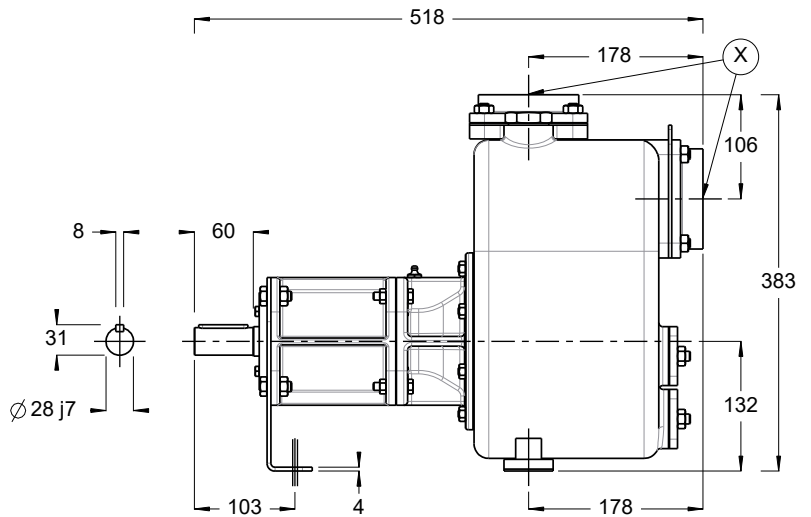
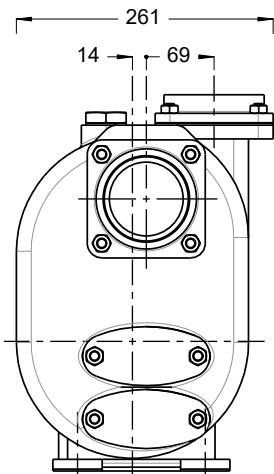

R3" BSP

