

S 82 K..B+F

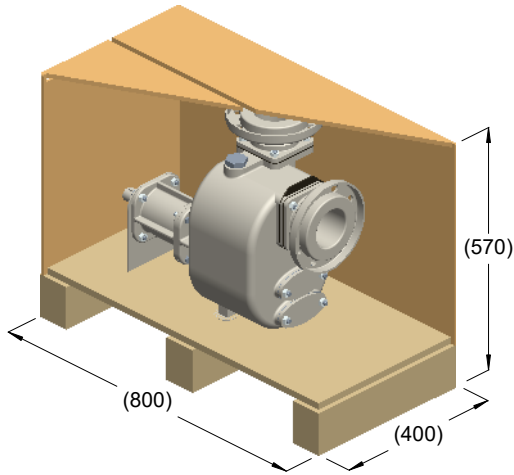

kg = 70
m³ = 0.18

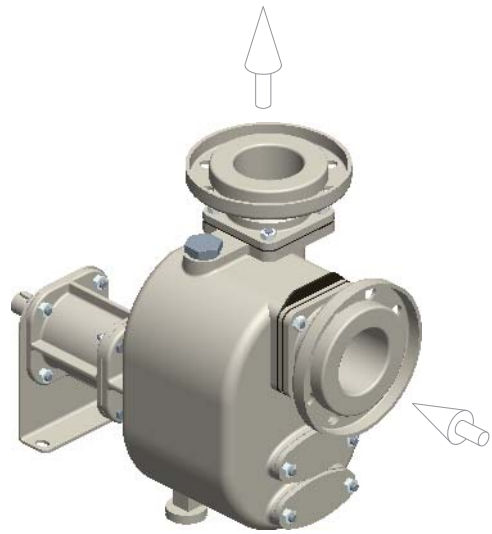

kg = 64

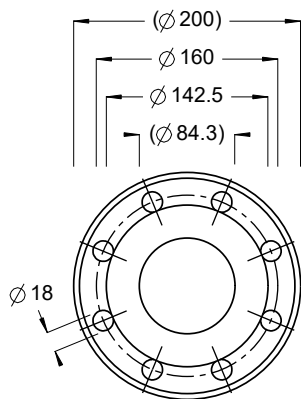
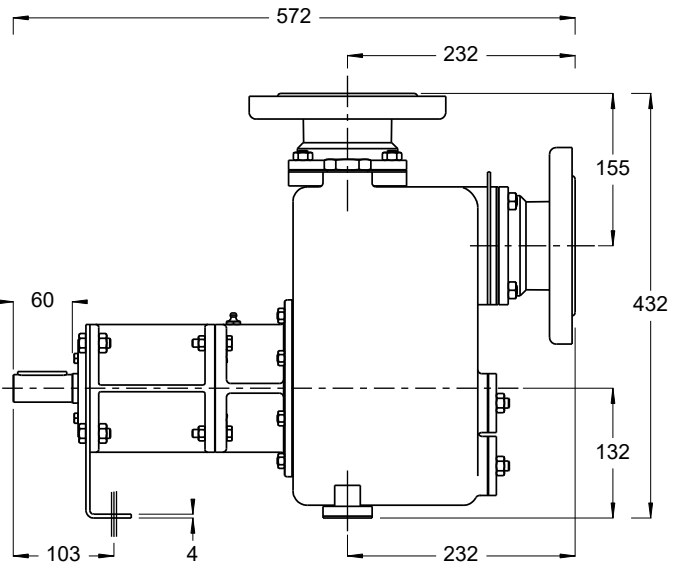
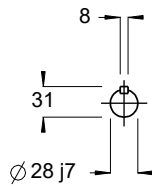
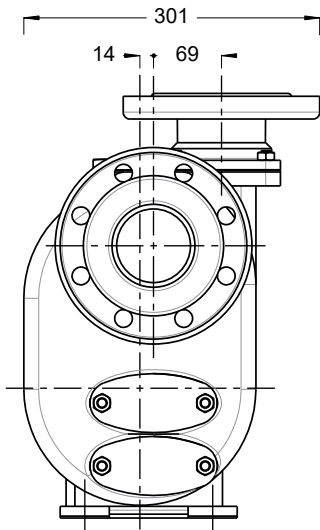

ISO DN80 PN16

