

**S 69 K..B+F**

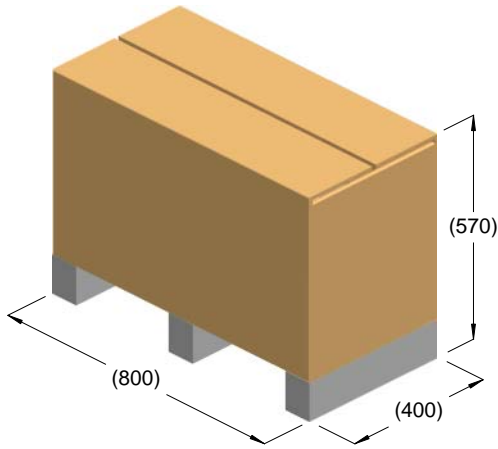

kg = 81  
m<sup>3</sup> = 0.18

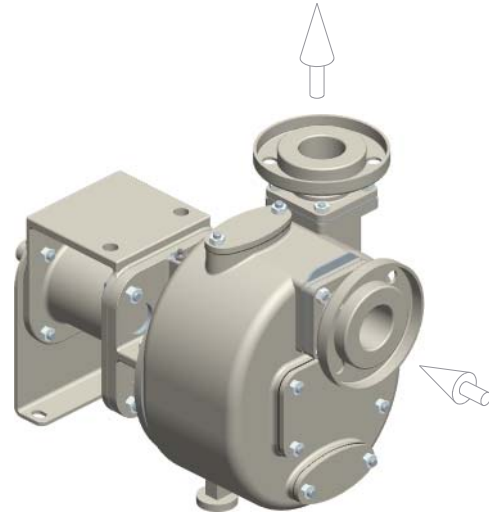

kg = 74

