

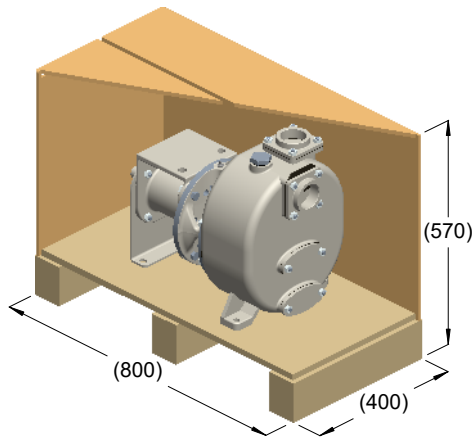

S 68 ...B

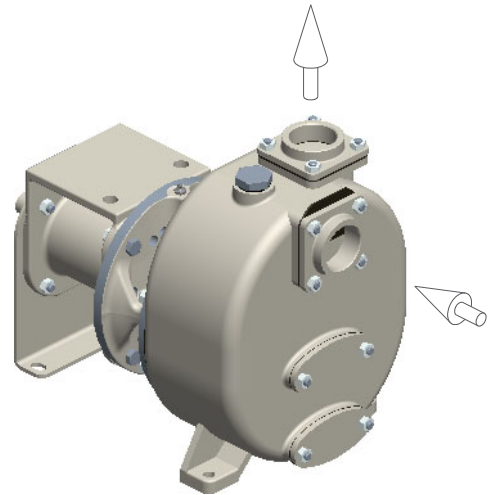

kg = 88
m³ = 0.18



kg = 82

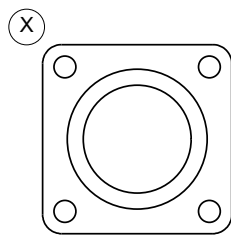
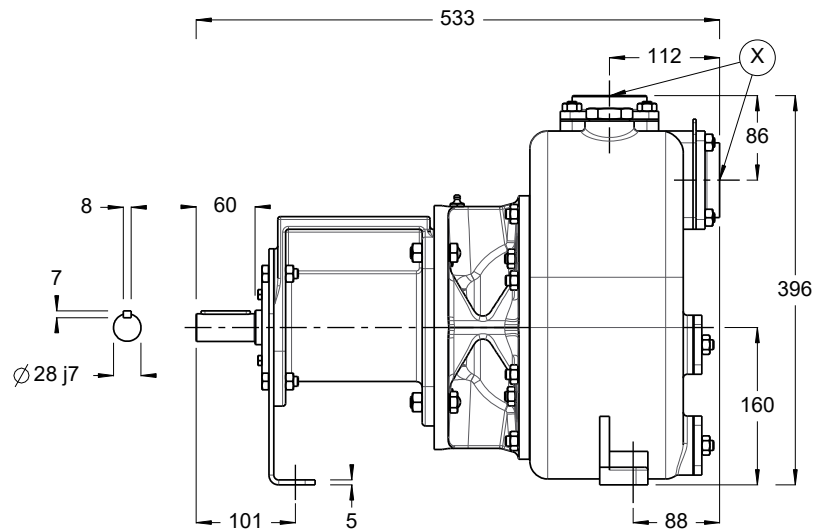
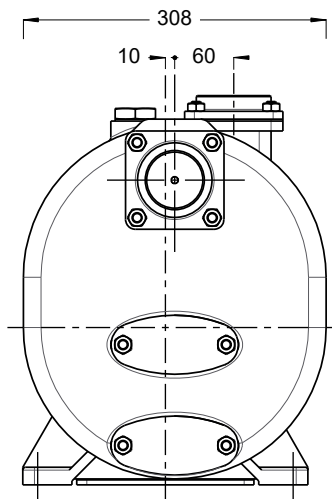

R2" BSP

