

**S 68 ...B+F**

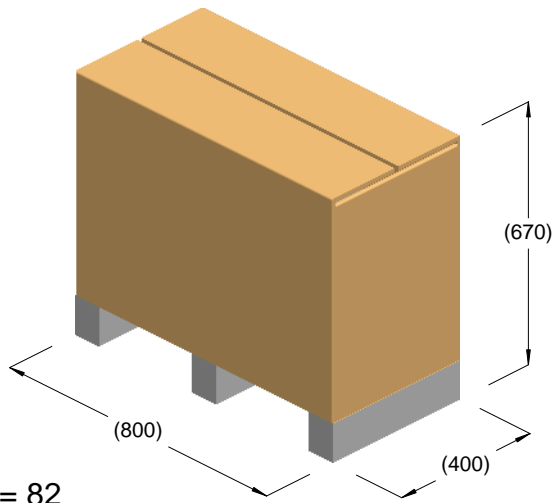

kg = 82  
m<sup>3</sup> = 0.21

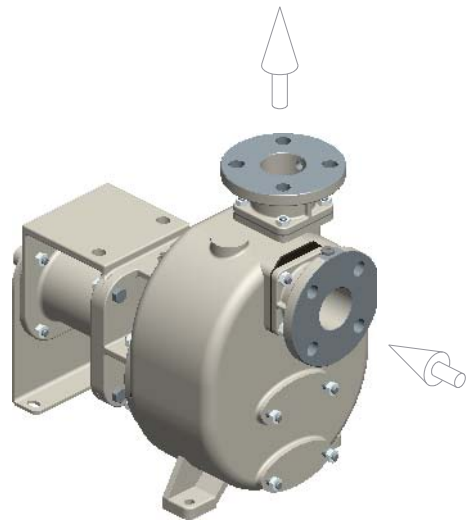

kg = 75

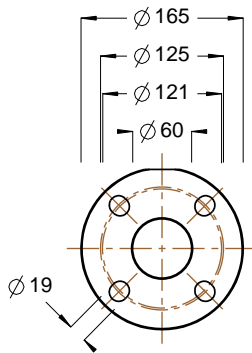
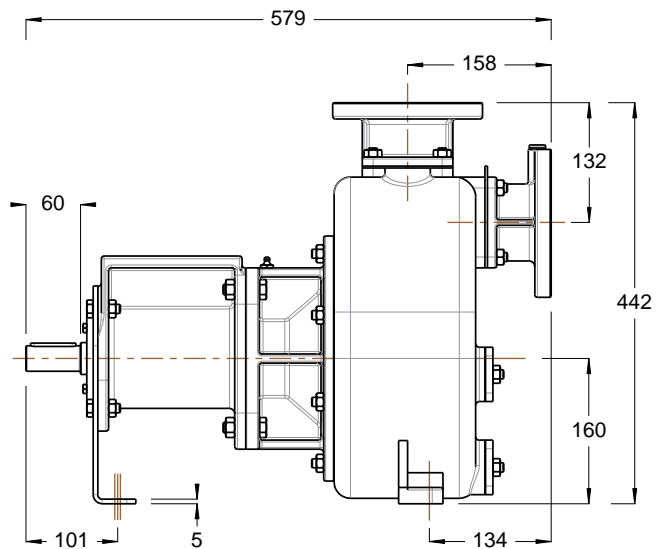
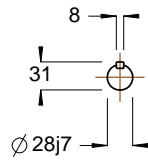
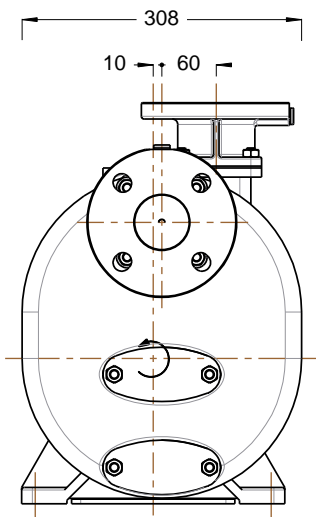

ISO DN50 PN16  
ANSI 2" 125lb

