

S 66 K..B

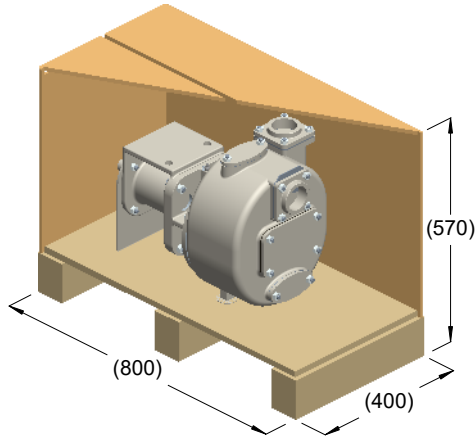

kg = 78
m³ = 0.18

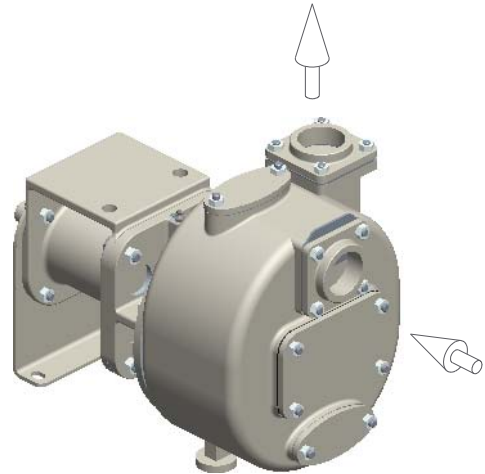

kg = 72

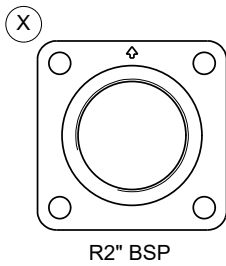
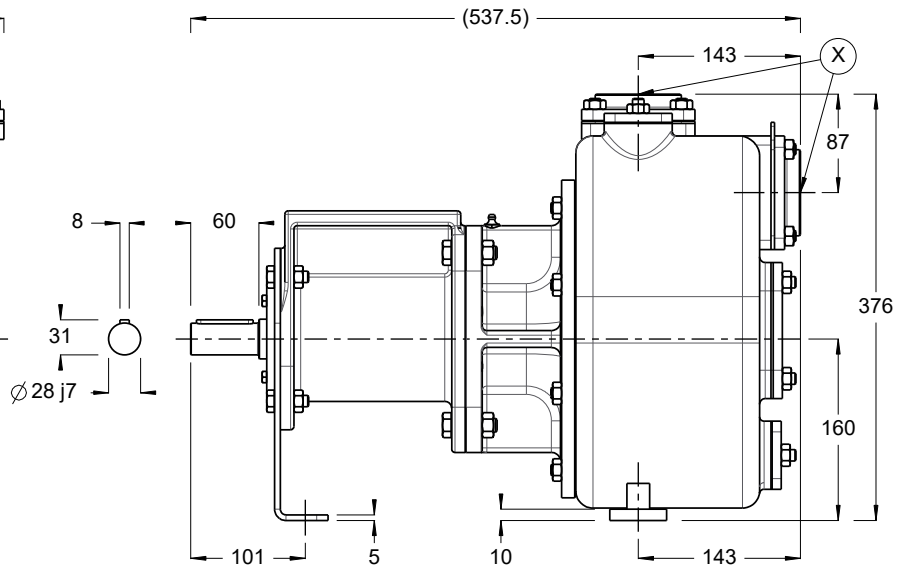
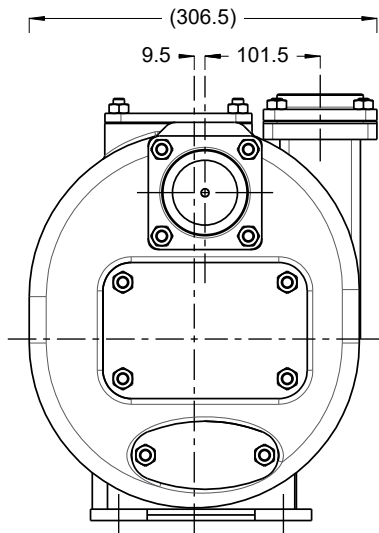

R2" BSP

