

S 66 K..B+F

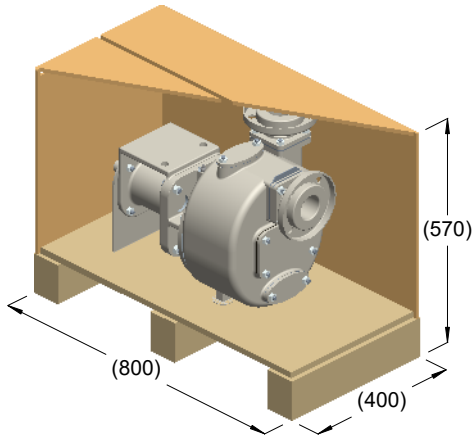

kg = 81
m³ = 0.18

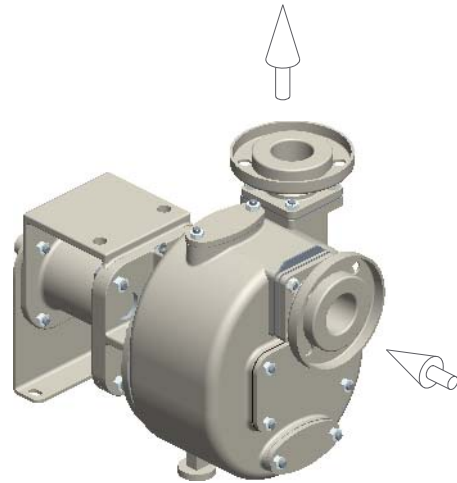

kg = 74

