

S 65 ...B

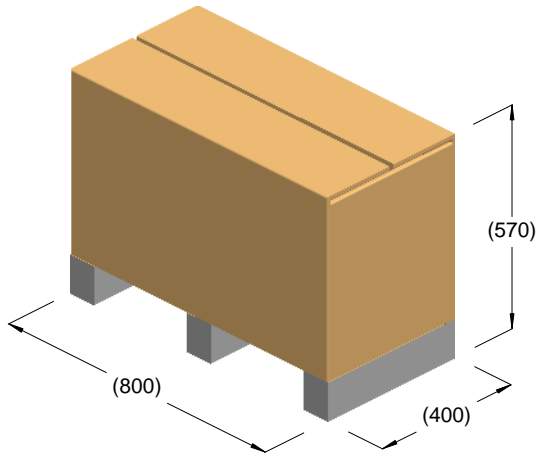

kg = 74
m³ = 0.18

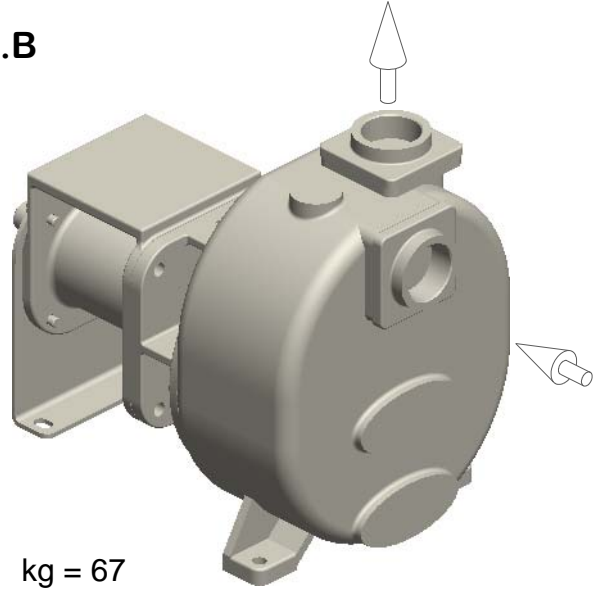

kg = 67

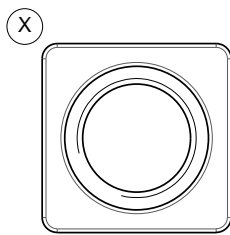
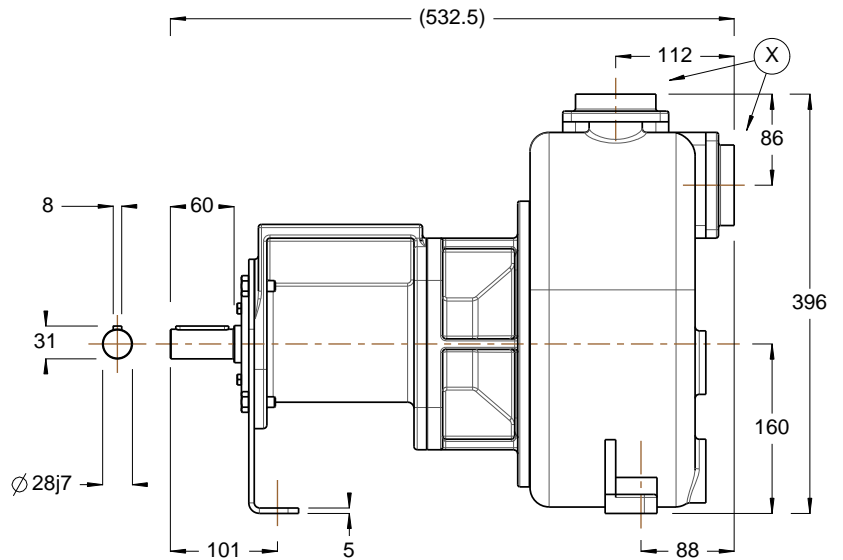
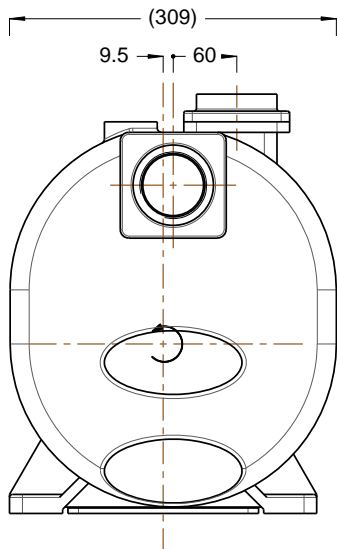

R2" BSP

