

S 65 ...B+F

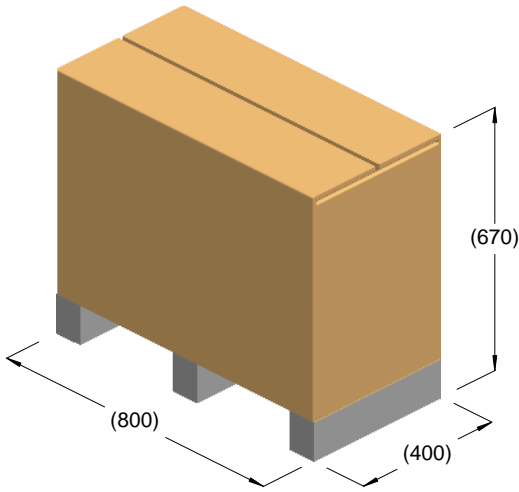

kg = 82
m³ = 0.21

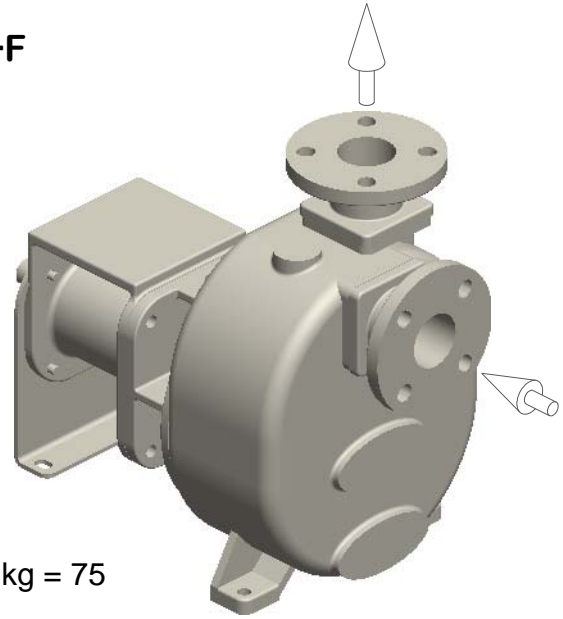

kg = 75

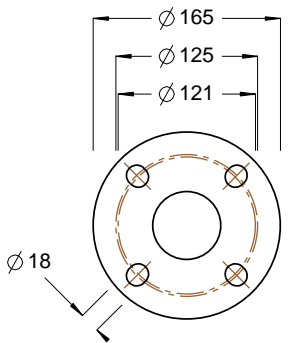
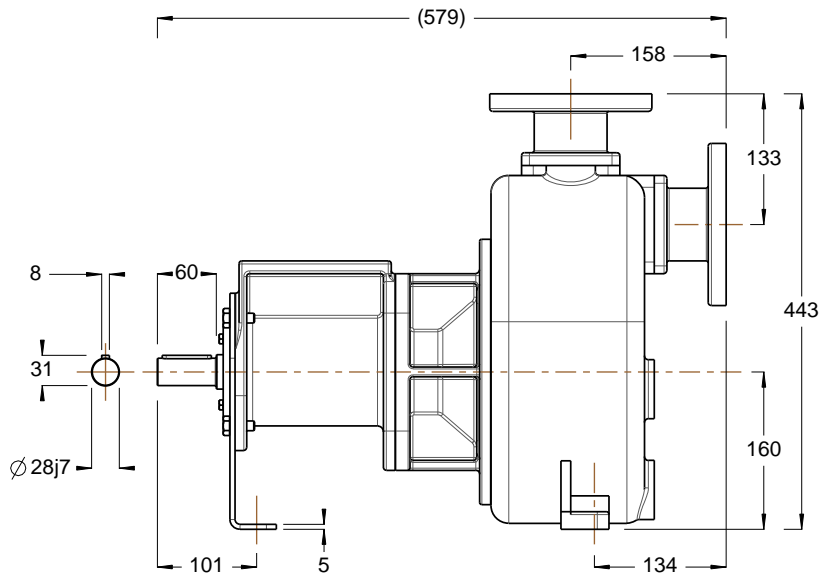
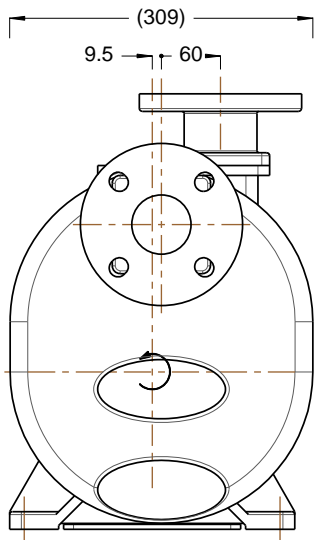

DN50 PN16 / ASA125 2"

