

S 63 ...B

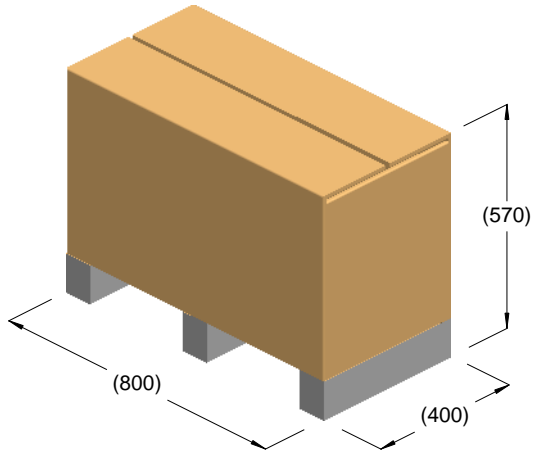

kg = 47
m³ = 0.18

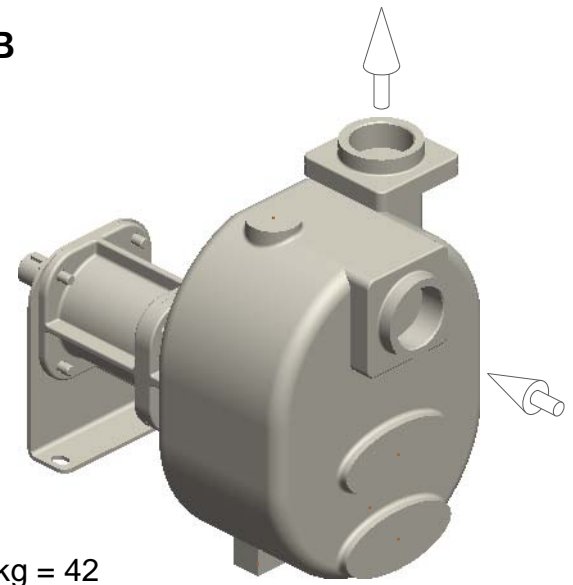

kg = 42

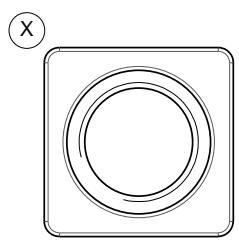
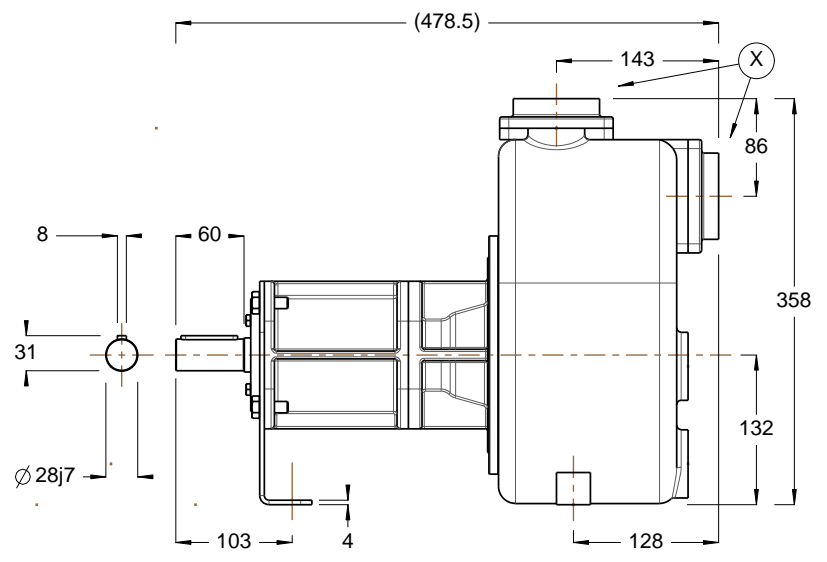
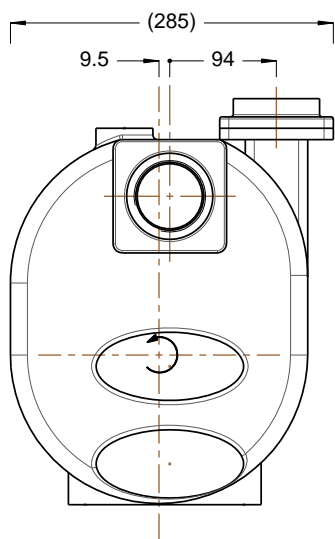

R2" BSP

