

S 63 ...B+F

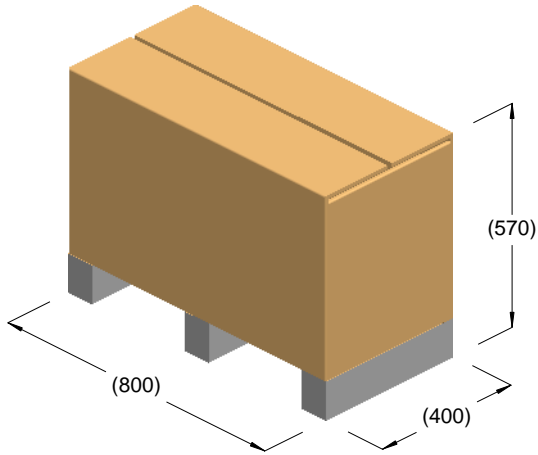

kg = 55
m³ = 0.18

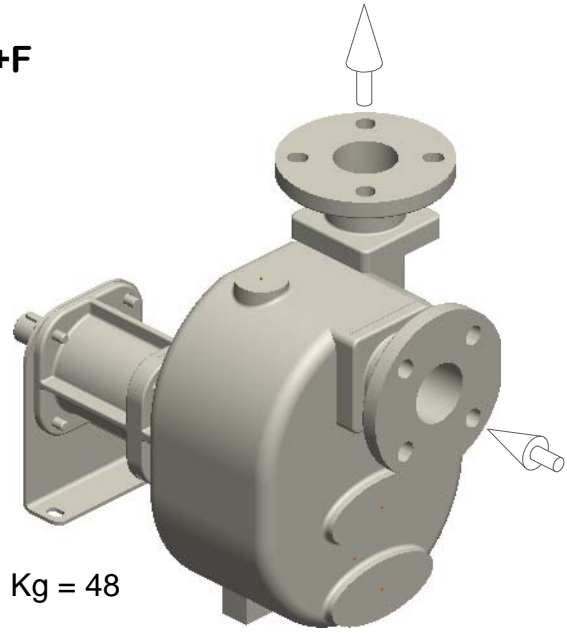

Kg = 48

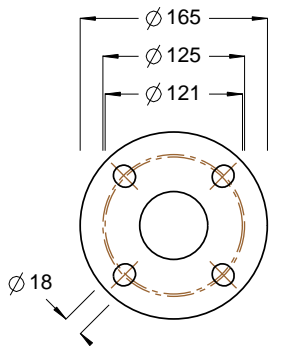
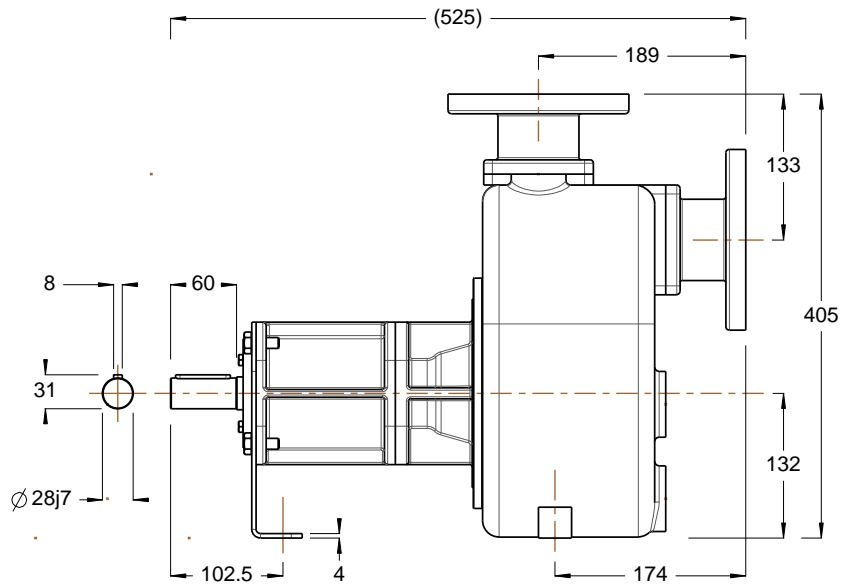
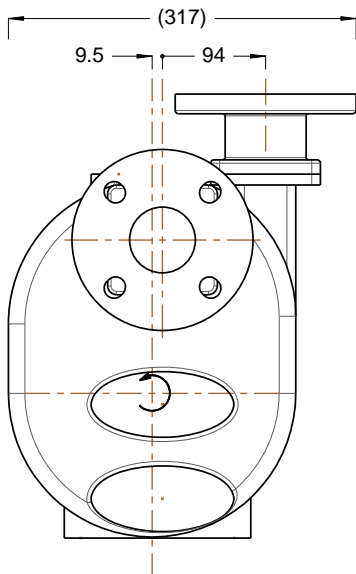

DN50 PN16 / ASA125 2"

