

S 60 ...B

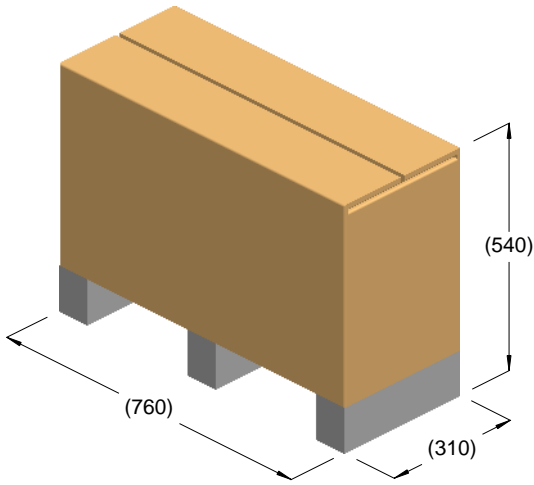

kg = 45
m³ = 0.13

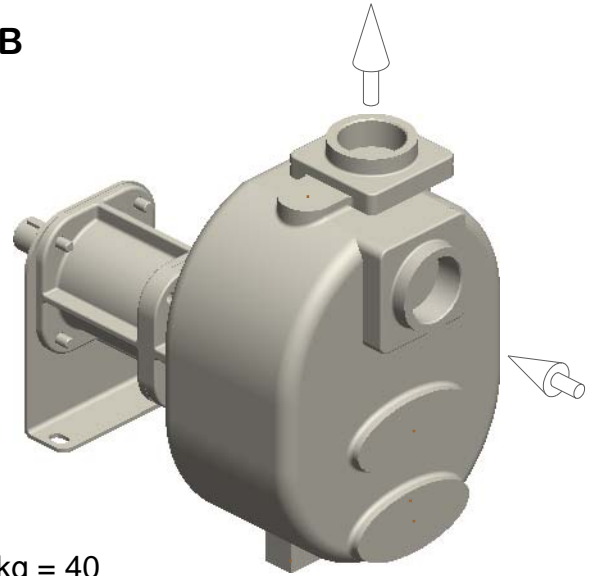

kg = 40

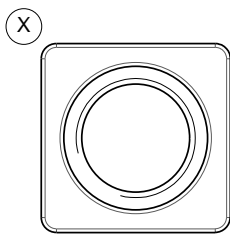
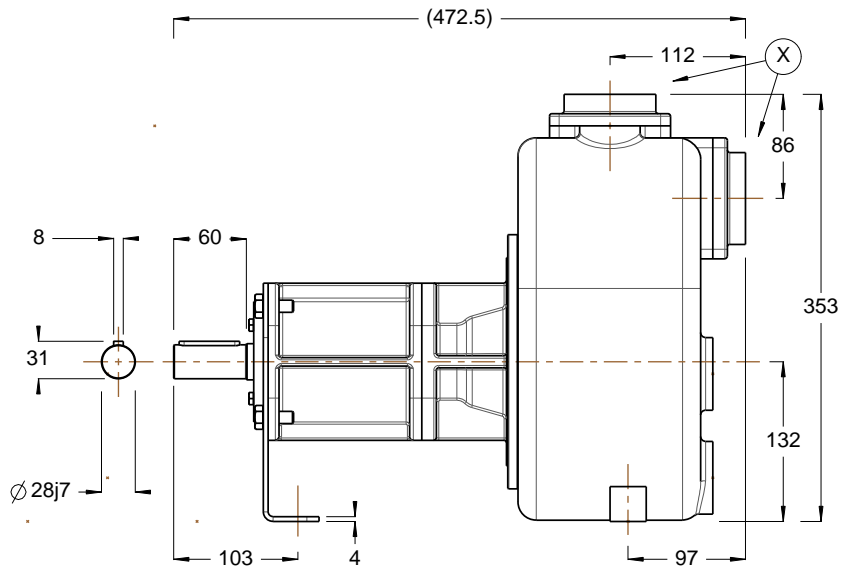
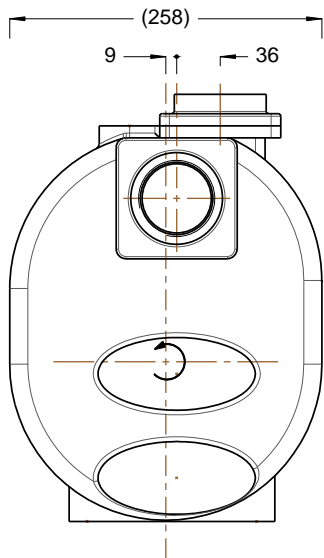

R2" BSP

