

S 60 ...B+F

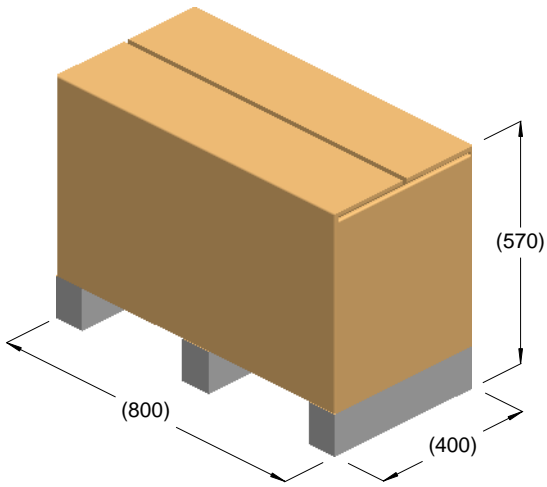

kg = 51
m³ = 0.18

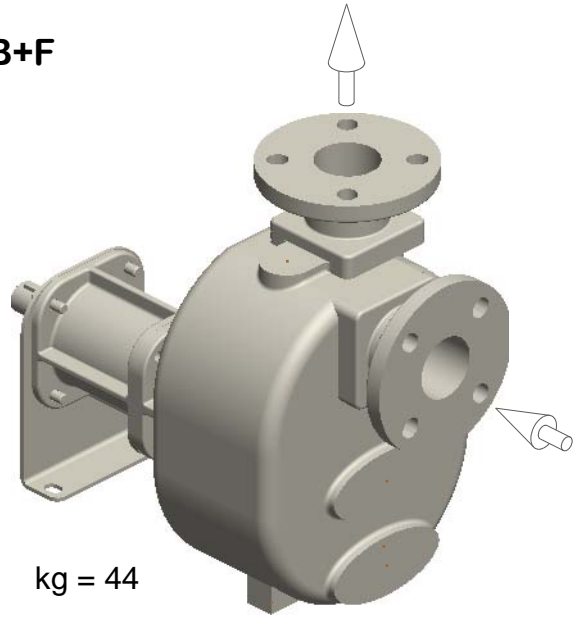

kg = 44

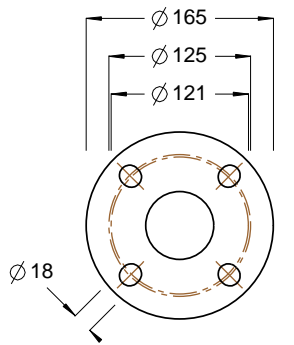
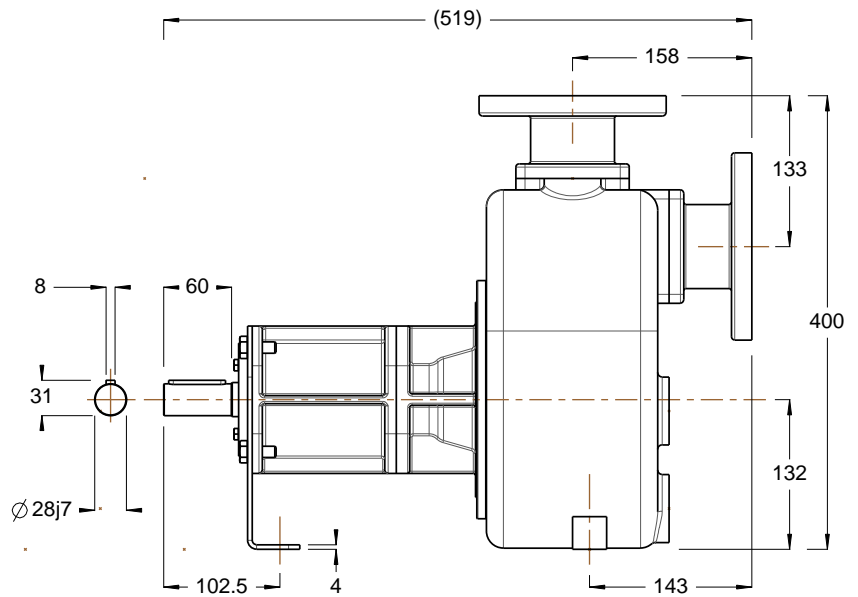
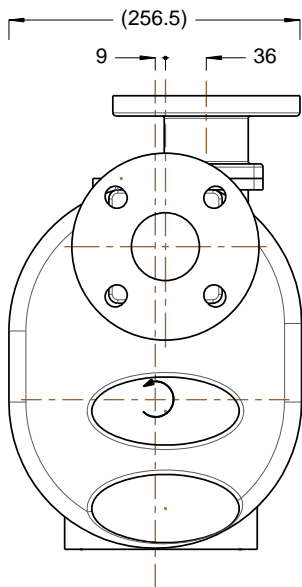

DN50 PN16 / ASA125 2"

