

S 51 K..S+F

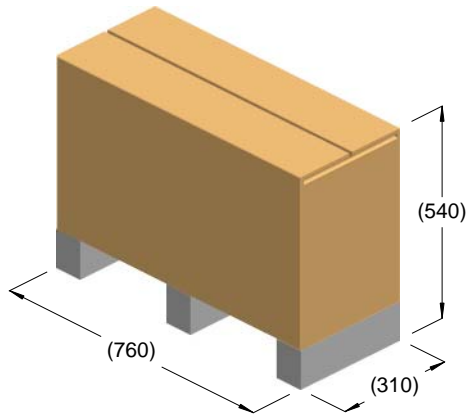

kg = 43
m³ = 0.13

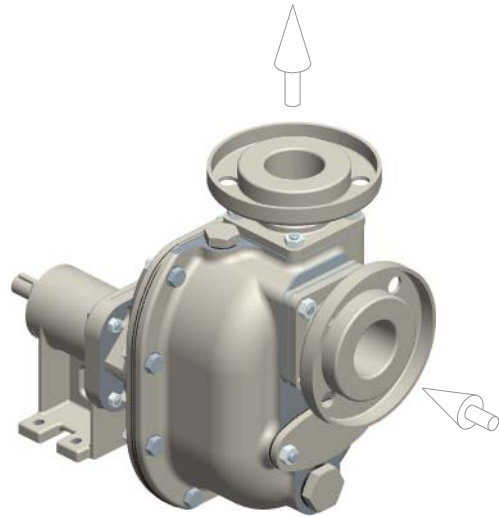

kg = 37

