

S 50 ...B

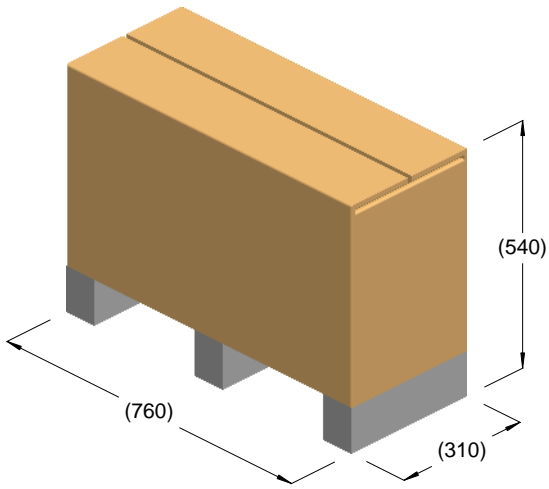

kg = 33
m³ = 0.13

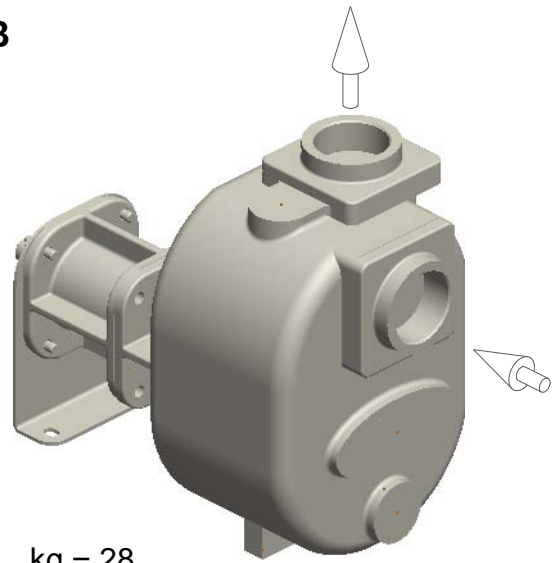

kg = 28

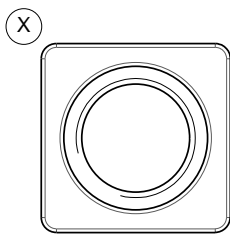
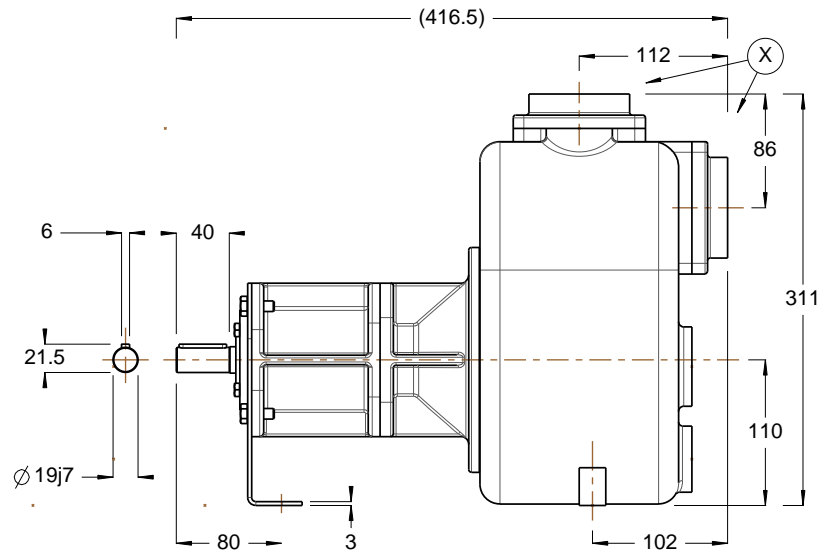
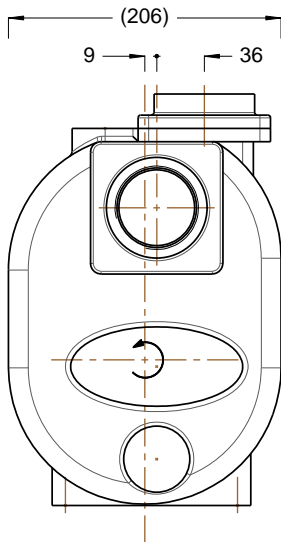

R2" BSP

