

S 50 ...B+F

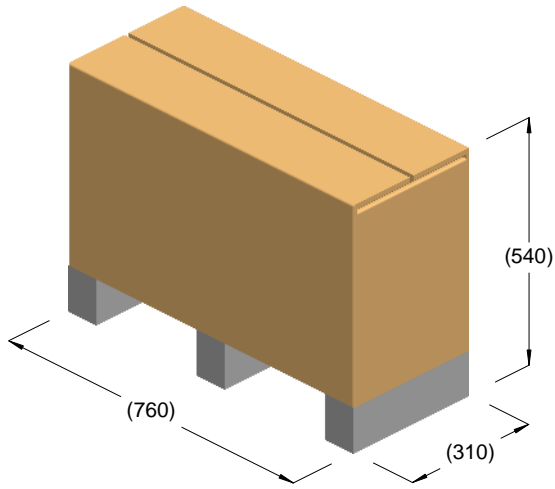

kg = 38
m³ = 0.13

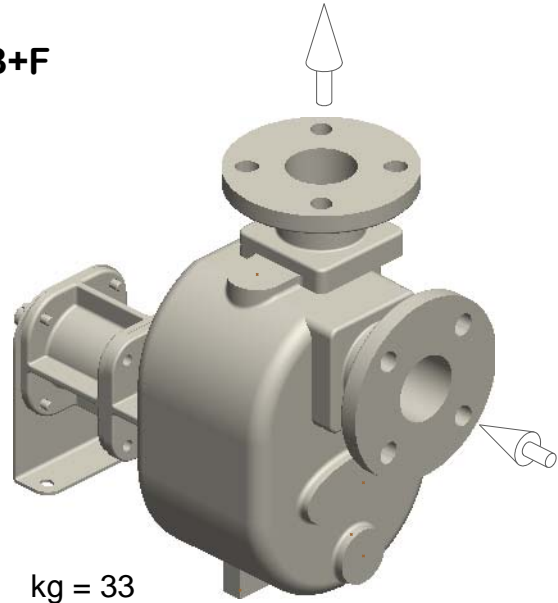

kg = 33

