

S230 ...B+F

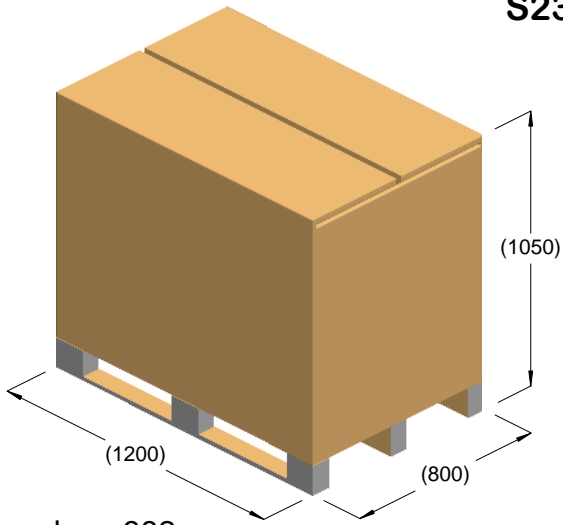

kg = 382
m³ = 1.01

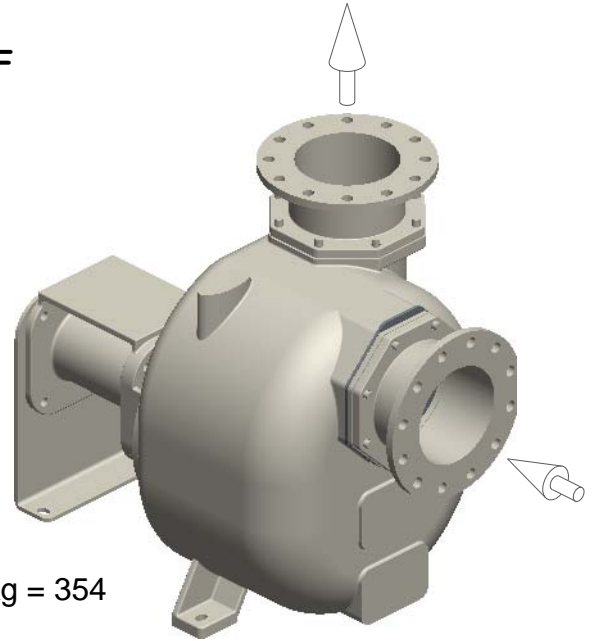

kg = 354

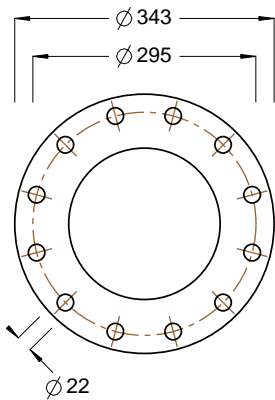
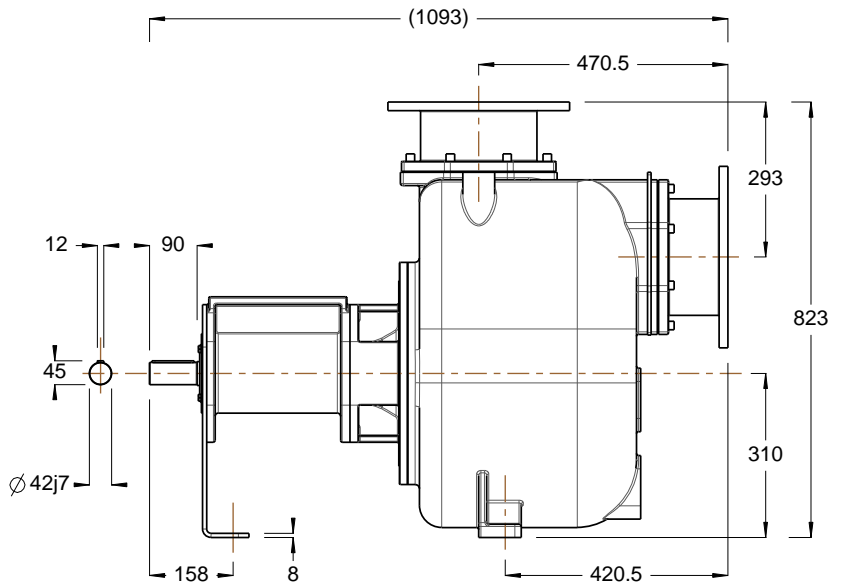
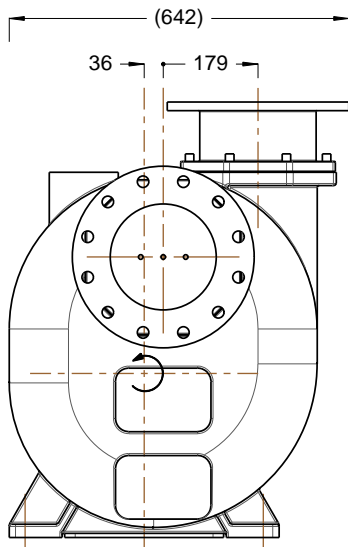

DN200 PN16 / ASA125 8"

