

S220 ...B+F

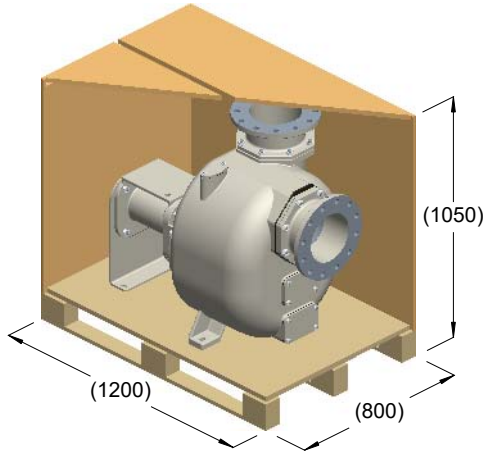

kg = 394
m³ = 0.11

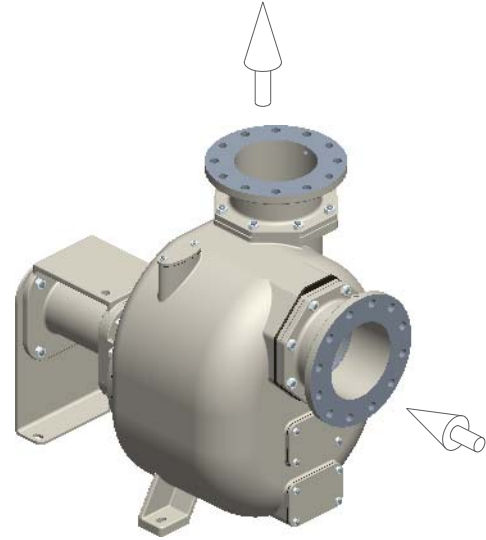

kg = 366

