

**S201 ...B**

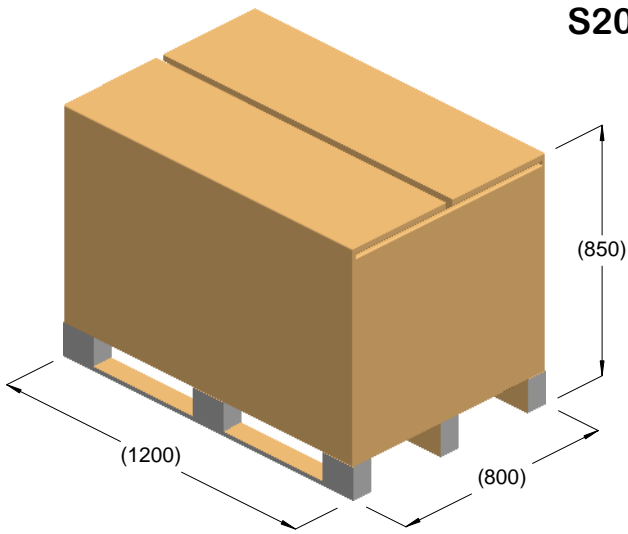

kg = 281  
m<sup>3</sup> = 0.82

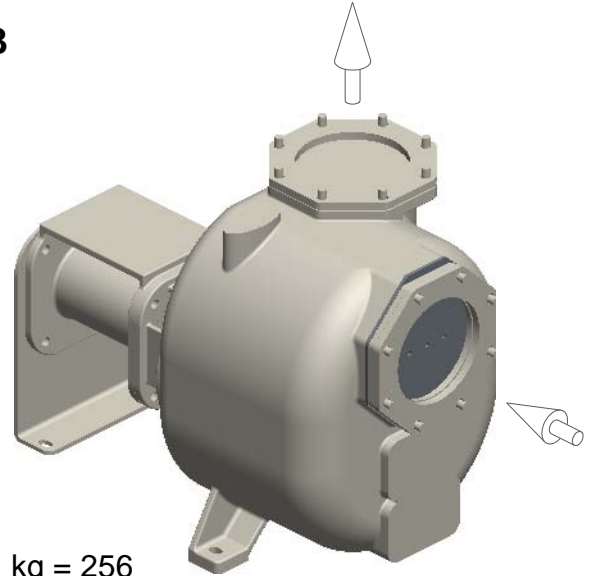

kg = 256

