

S201 ...B+F

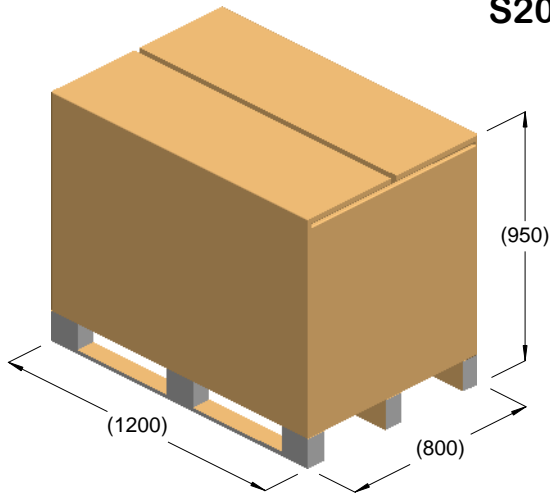

kg = 310
m³ = 0.91

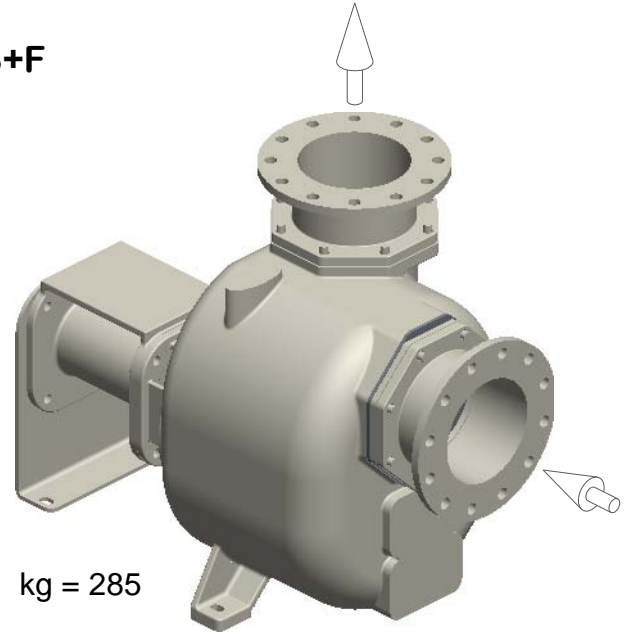

kg = 285

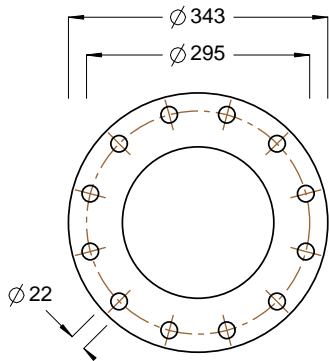
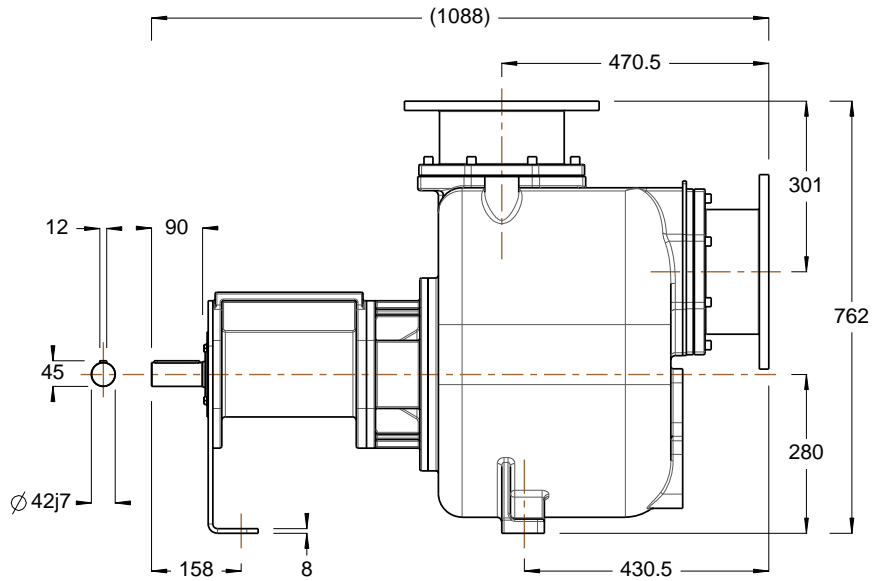
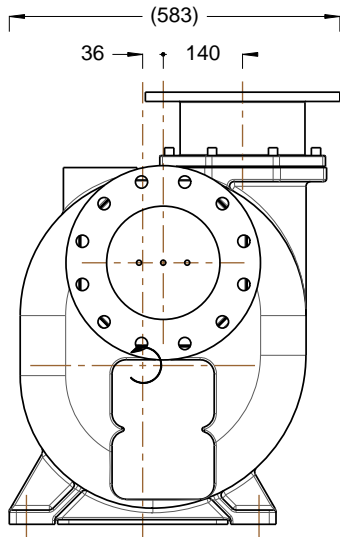

DN200 PN16 / ASA125 8"

