

S170 ...B

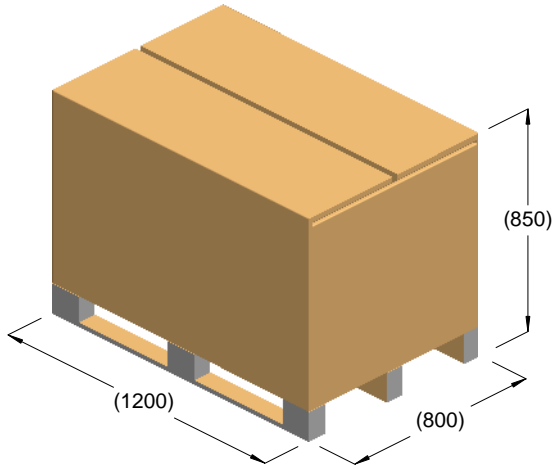

kg = 282
m³ = 0.82

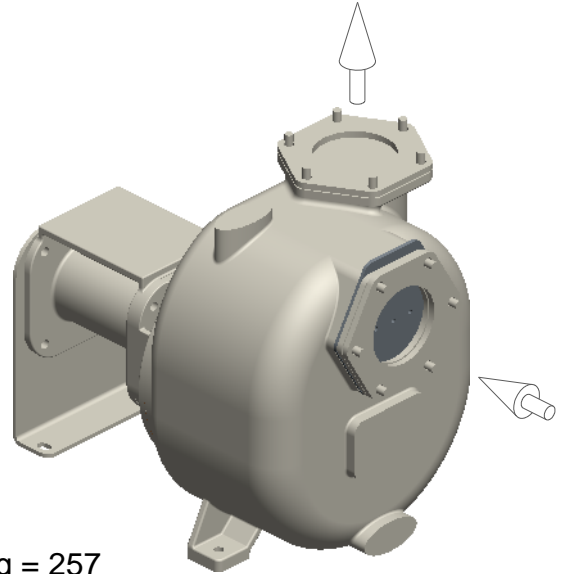

kg = 257

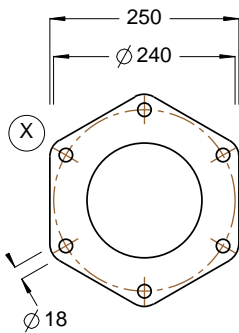
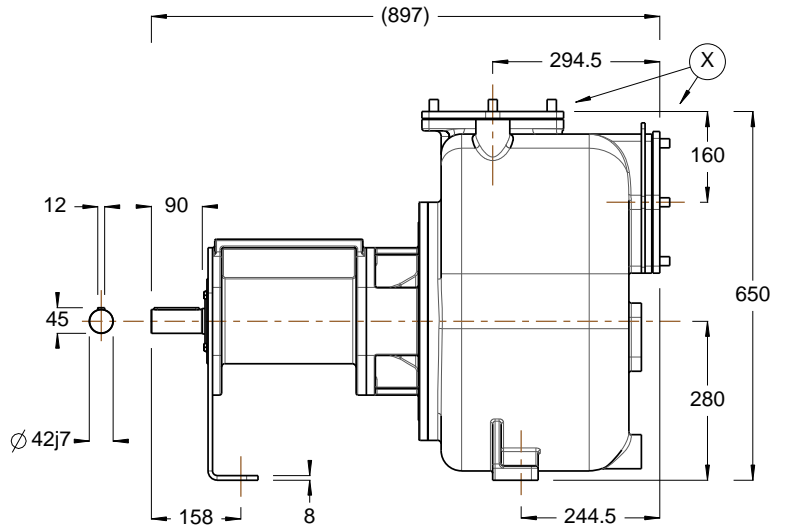
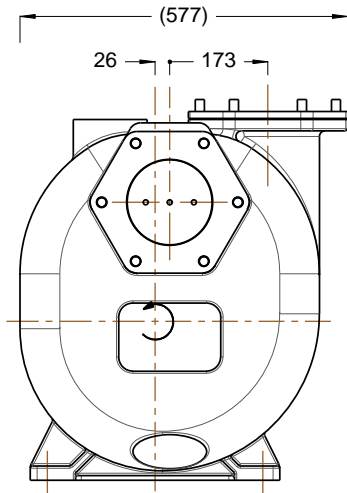

TO WELD

