

S170 ...B+F

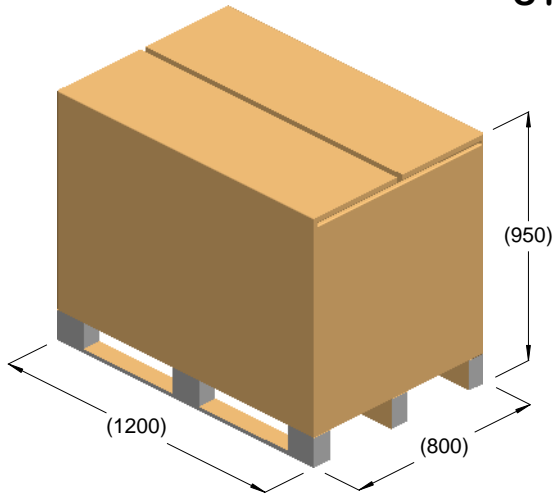

kg = 297
m³ = 0.91

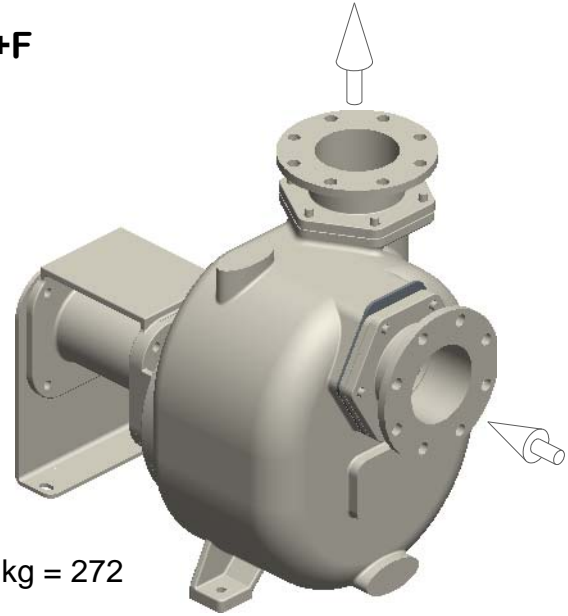

kg = 272

