

S150 ...B+F

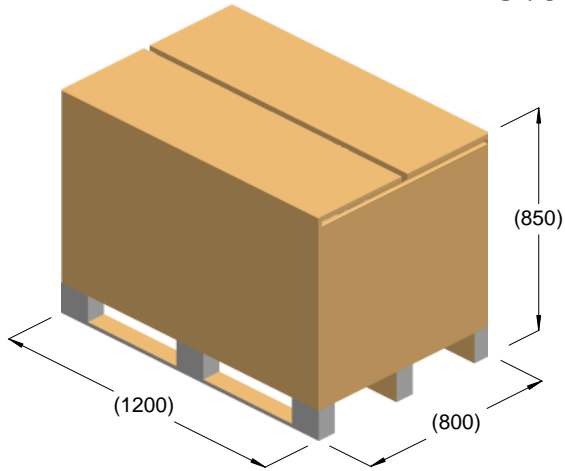

kg = 176
m³ = 0.82

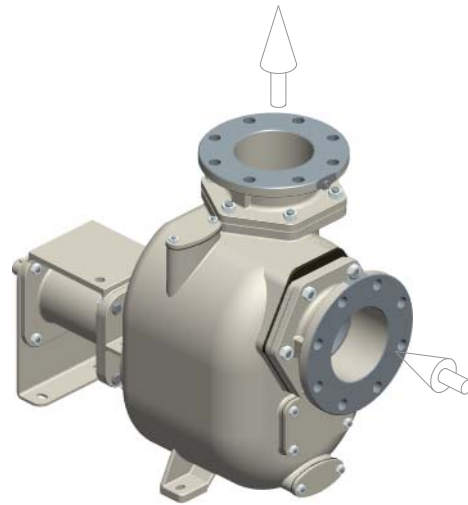

kg = 151

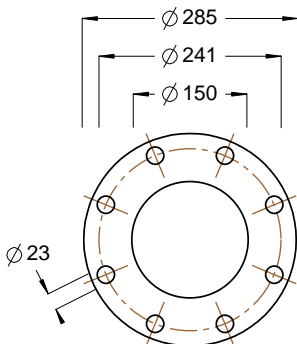
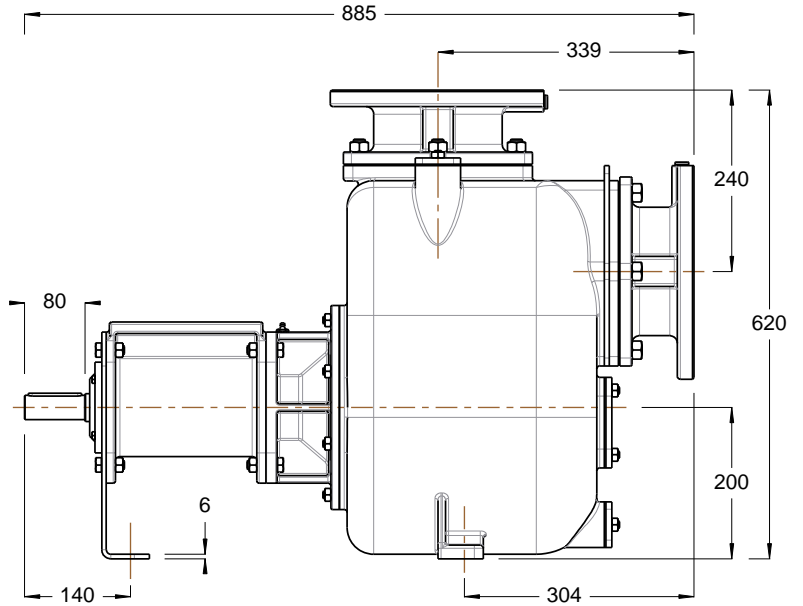
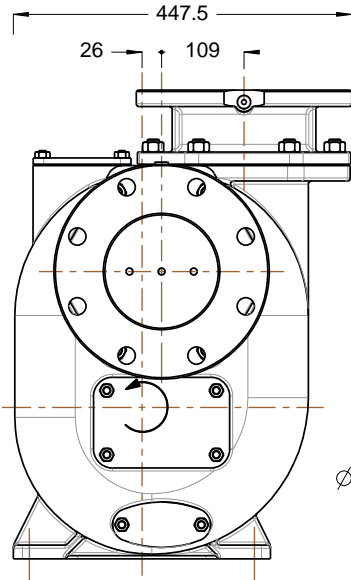

ISO DN150 PN16
ANSI 6" 150lb

