

S126 ...B

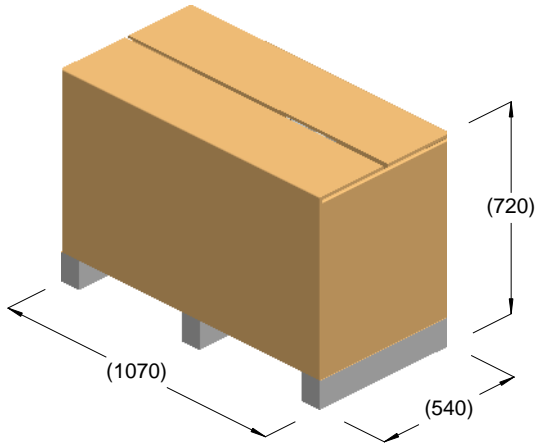

kg = 203
m³ = 0.42

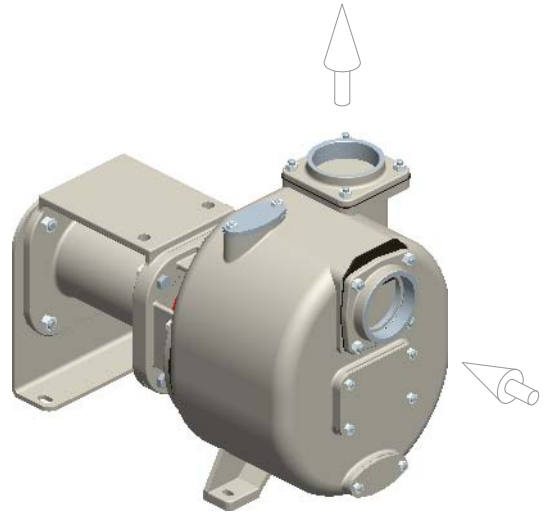

kg = 189

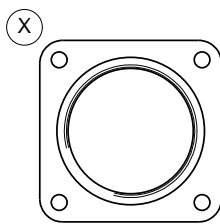
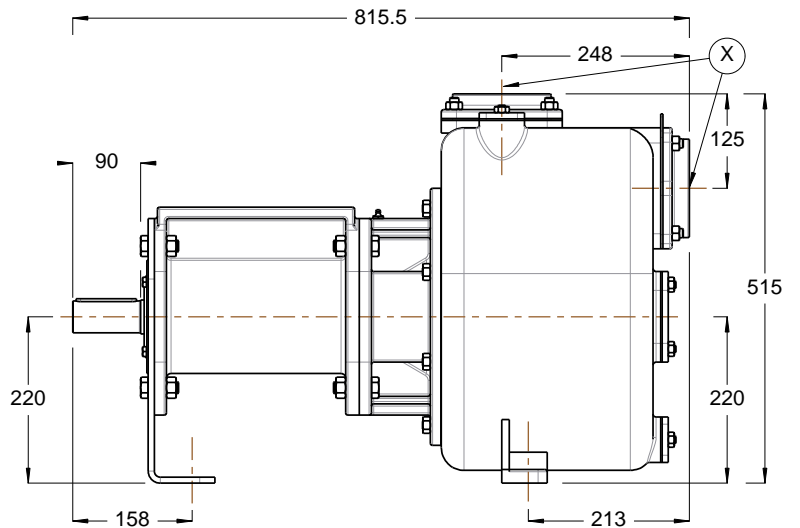
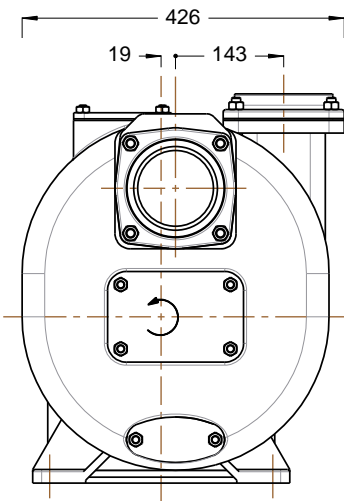

R4" BSP

