

**S126 ...B+F**

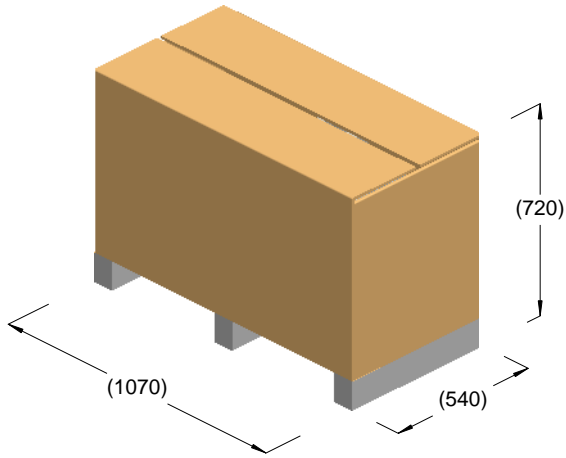

kg = 215  
m<sup>3</sup> = 0.42

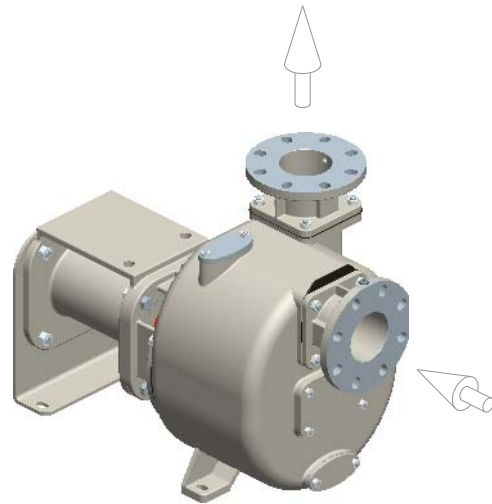

kg = 201

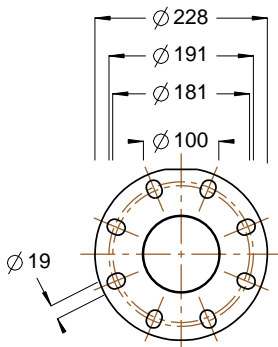
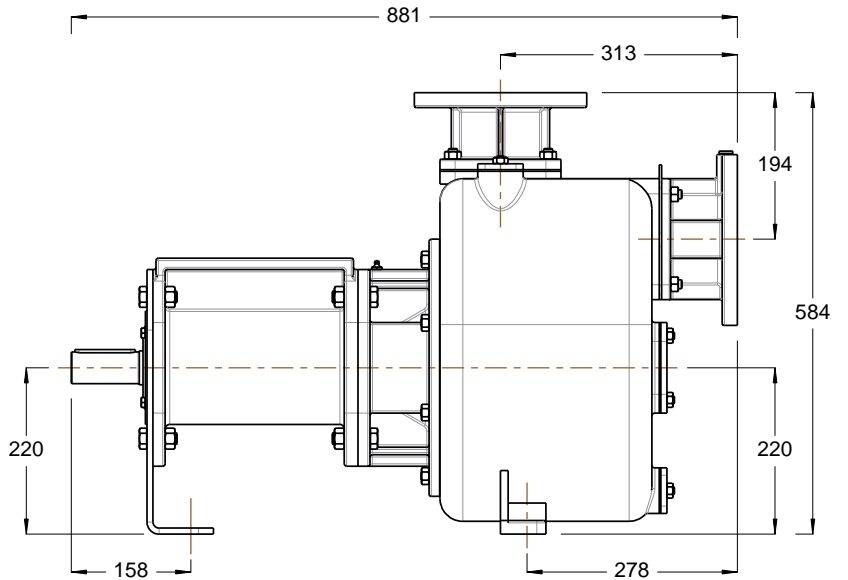
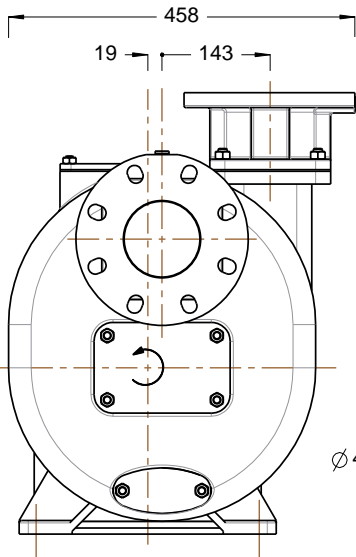

ISO DN100 PN16  
ANSI 4" 125lb

