

S121 ...B

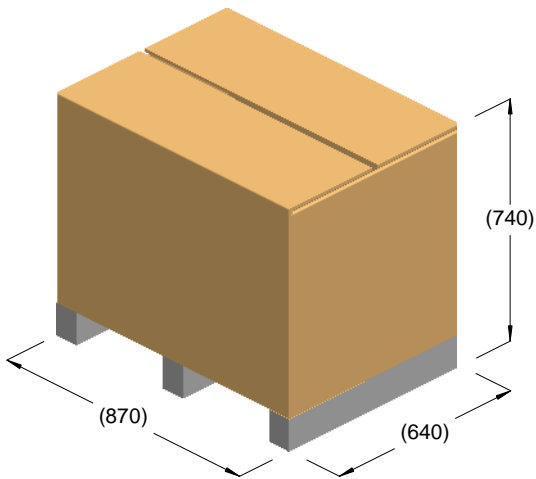

kg = 157
m³ = 0.41

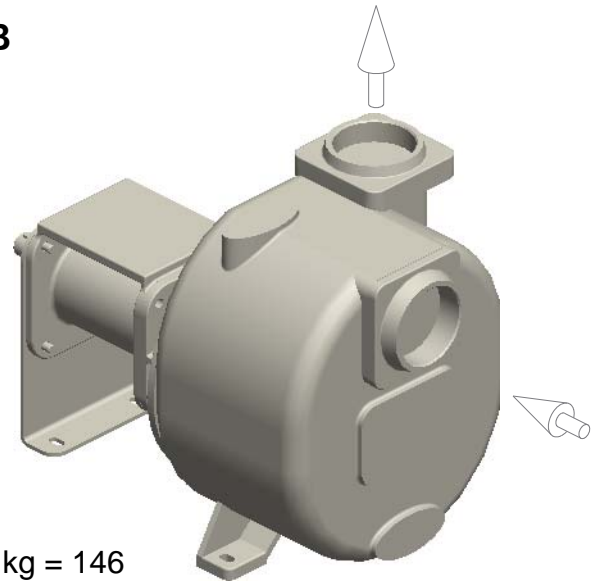

kg = 146

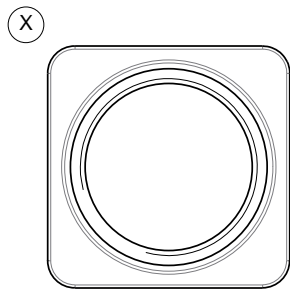
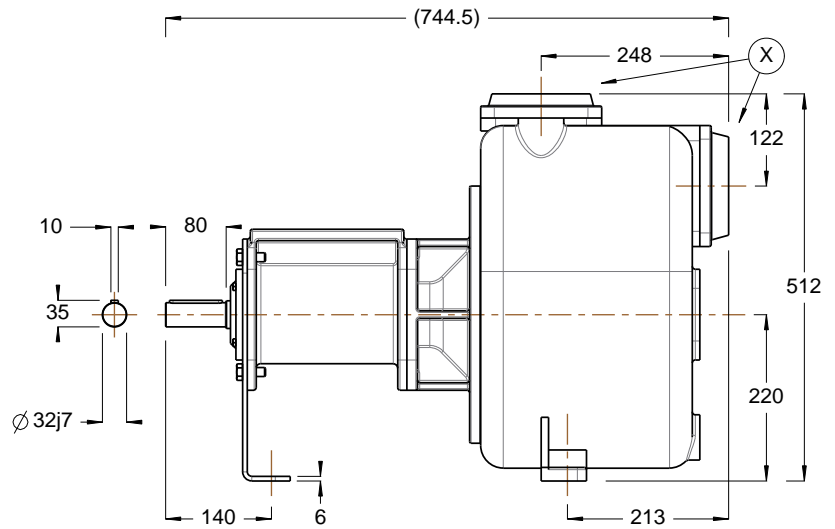
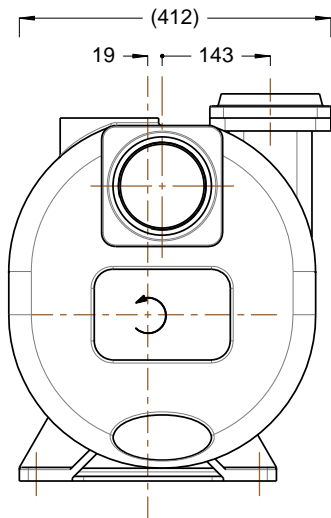

R4" BSP

