

S121 ...B+F

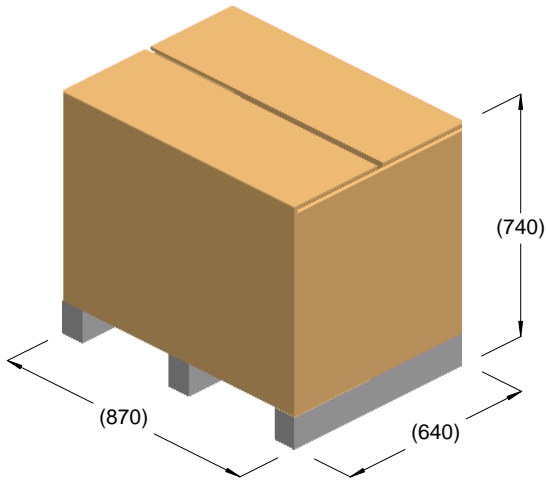

kg = 173
m³ = 0.41

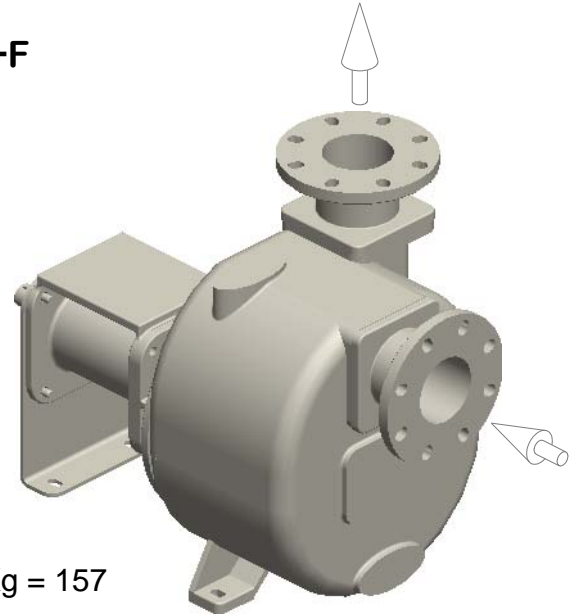

Kg = 157

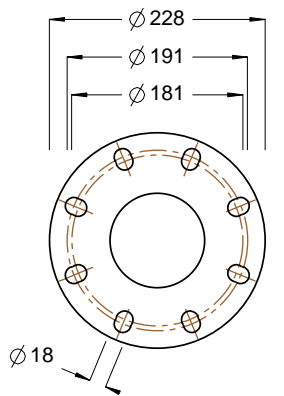
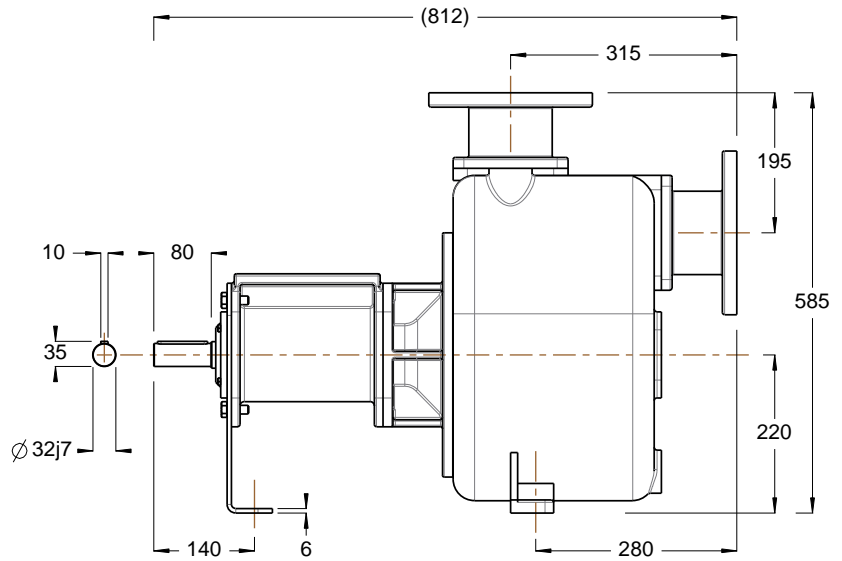
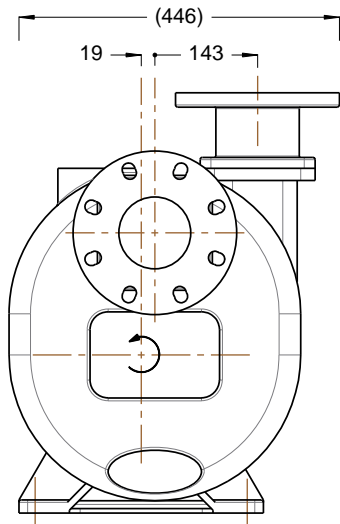

DN100 PN16 / ASA125 4"

