

S108 K..B+F

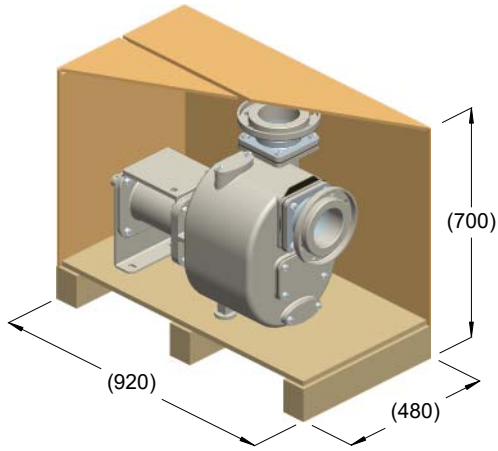

kg = 146
m³ = 0.31

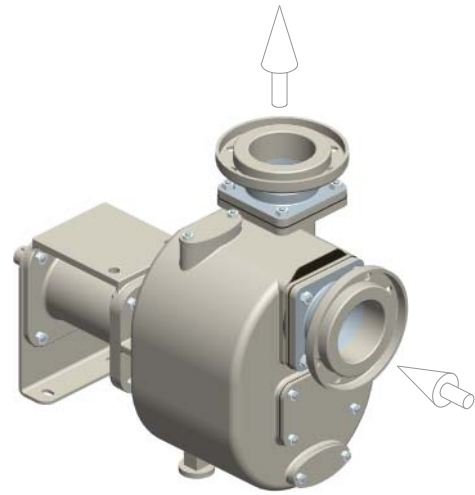

kg = 137

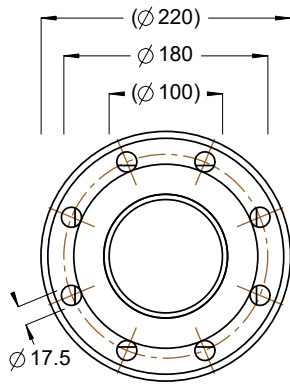
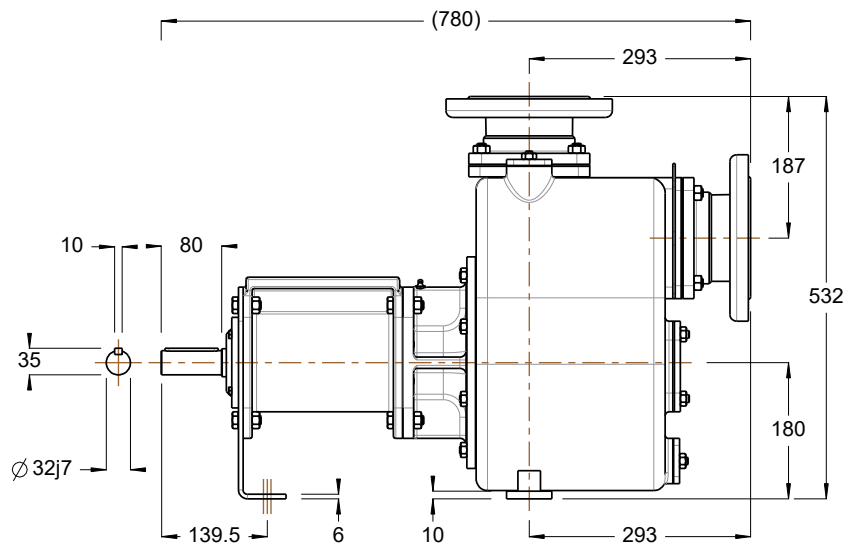
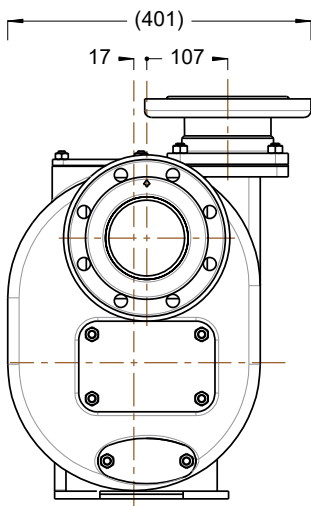

ISO DN100 PN16

