

S105 K..B

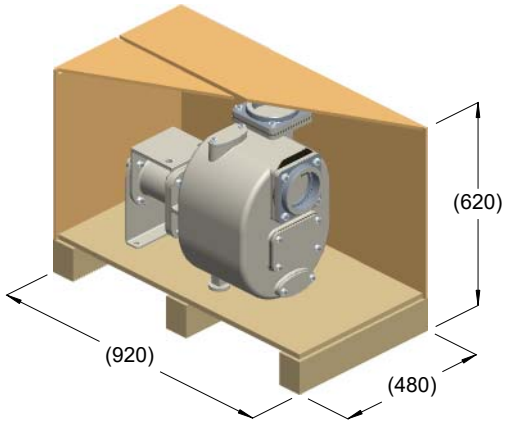

kg = 130
m³ = 0.27

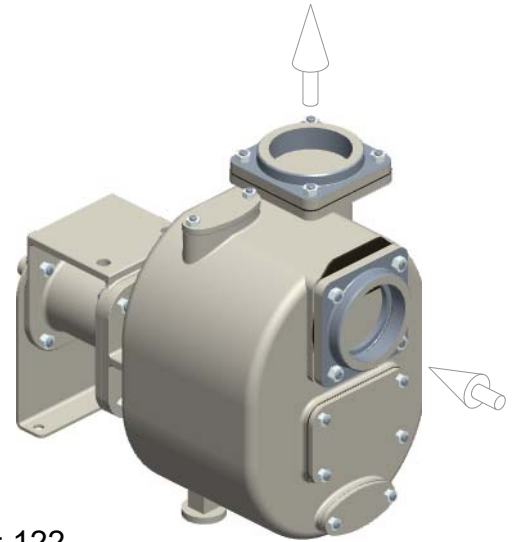

kg = 122

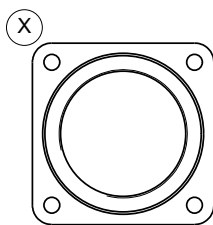
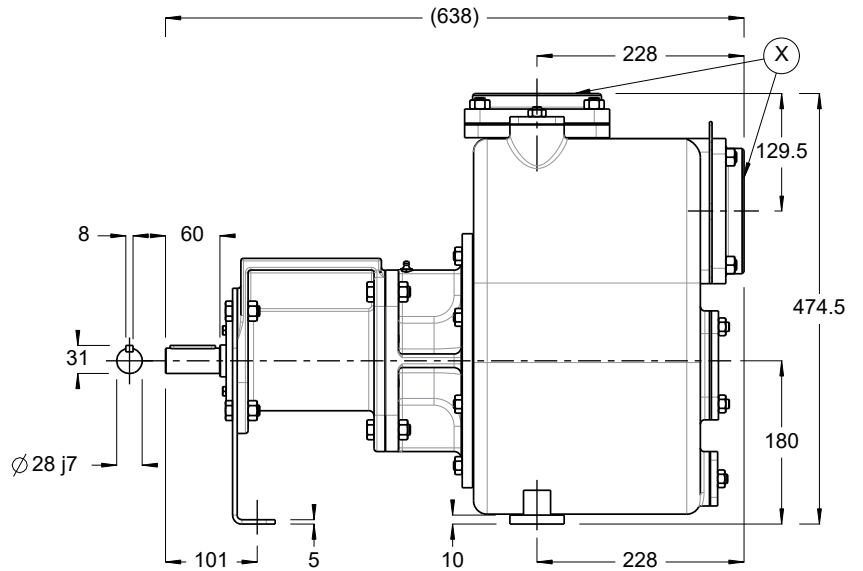
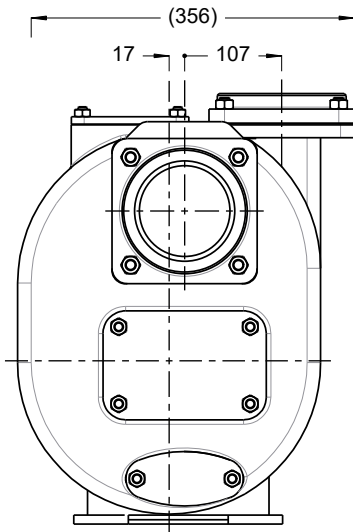

R4" BSP

