

S105 K..B+F

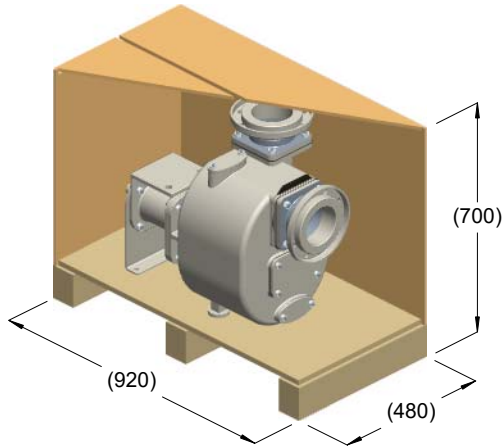

kg = 137
m³ = 0.31

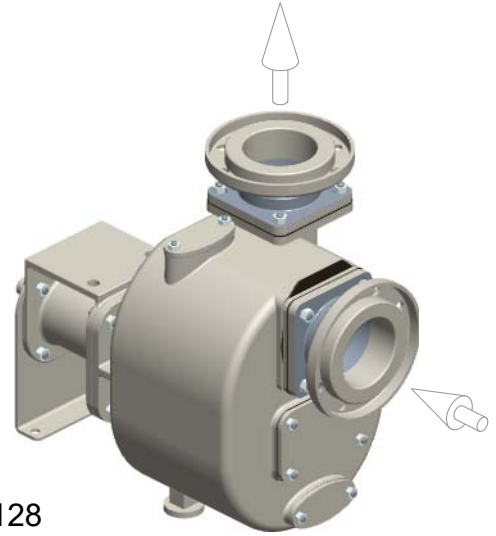

kg = 128

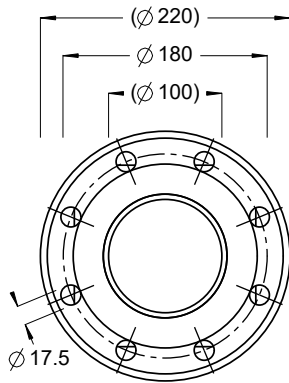
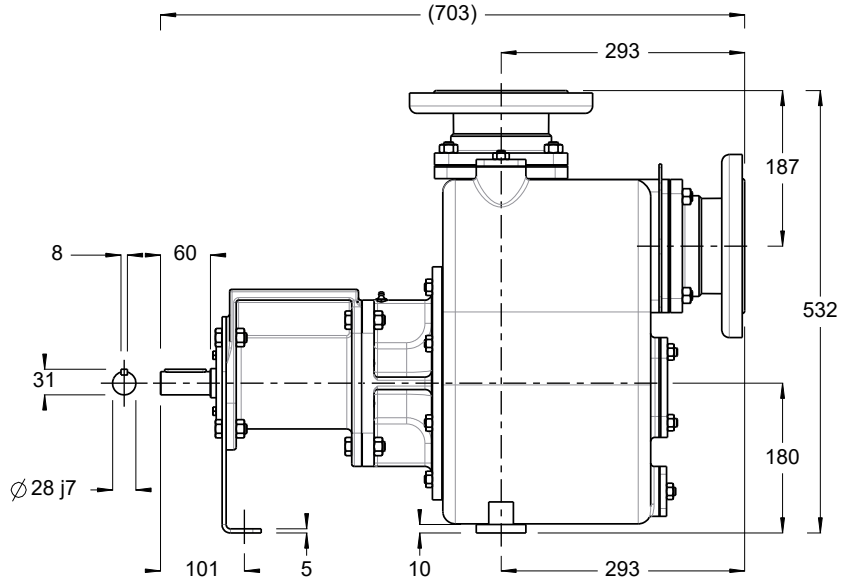
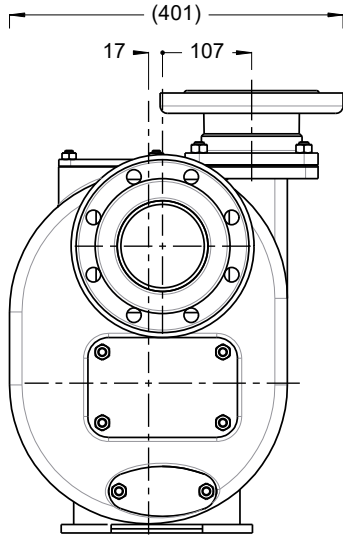

ISO DN100 PN16

