

S105 ...B

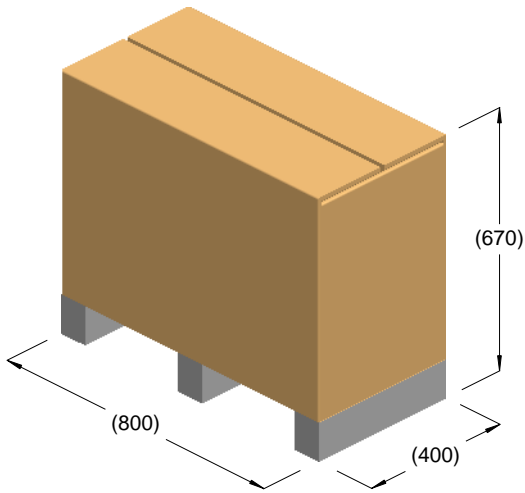

kg = 106
m³ = 0.21

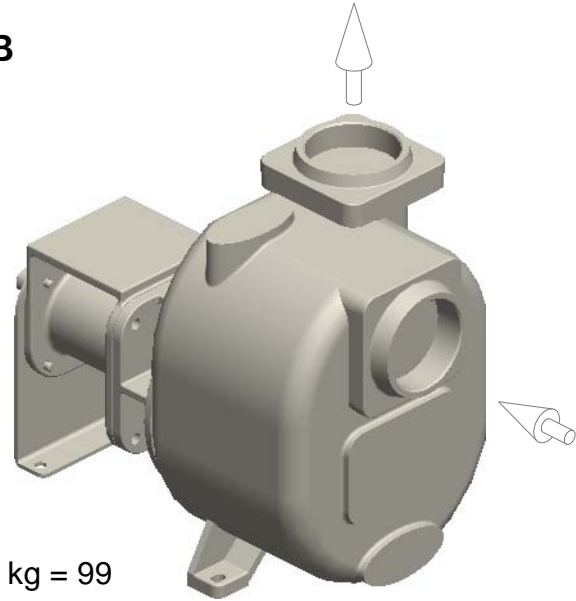

kg = 99

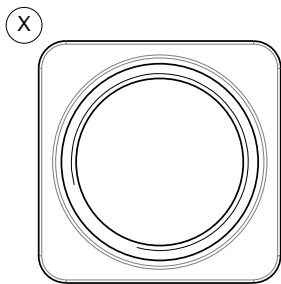
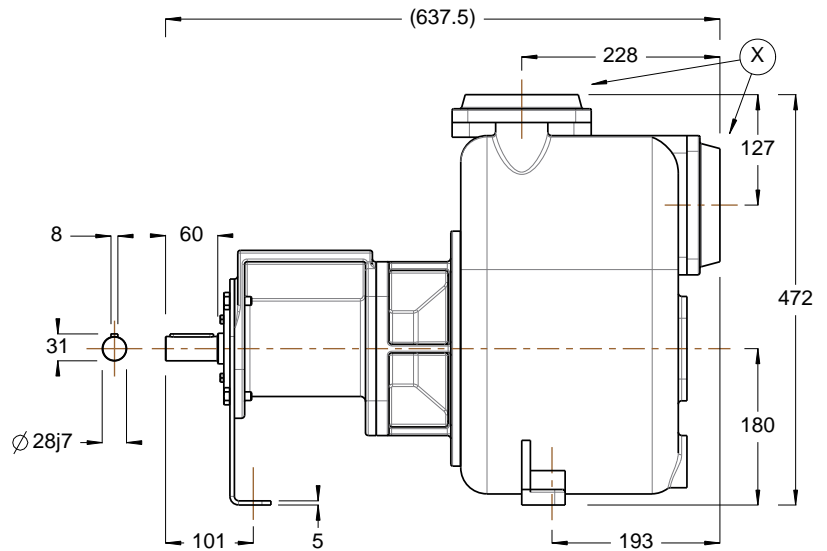
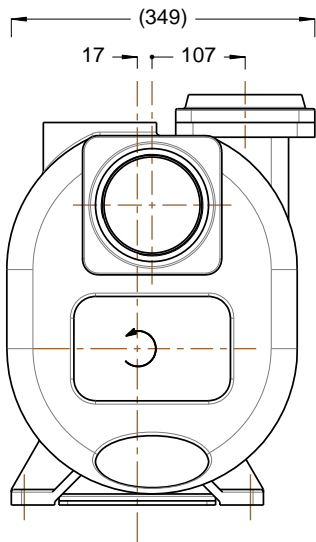

R4" BSP

