

**S100 ...B**

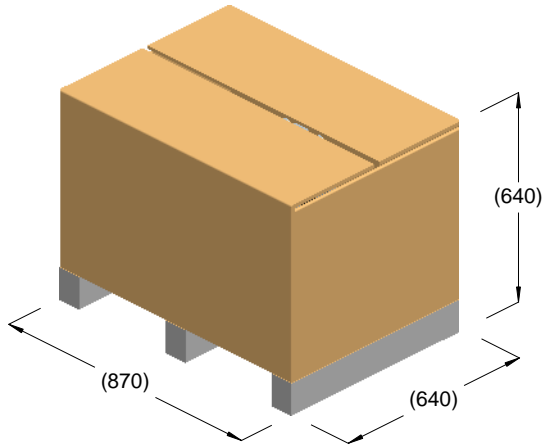

kg = 91  
m<sup>3</sup> = 0.36

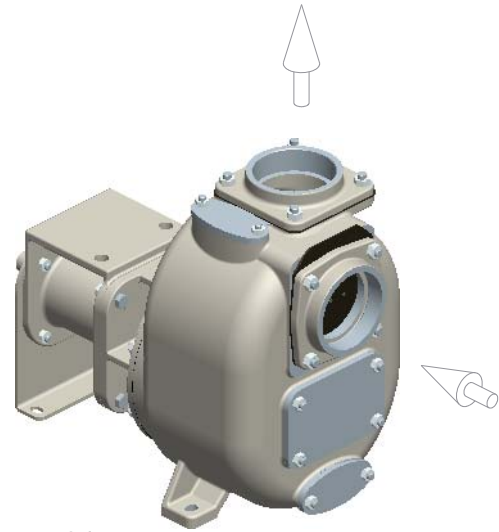

kg = 81

