

R 51 .L.B+Y

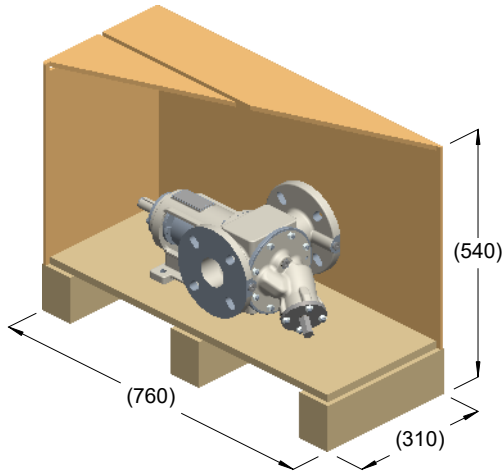

kg = 43
m³ = 0.13

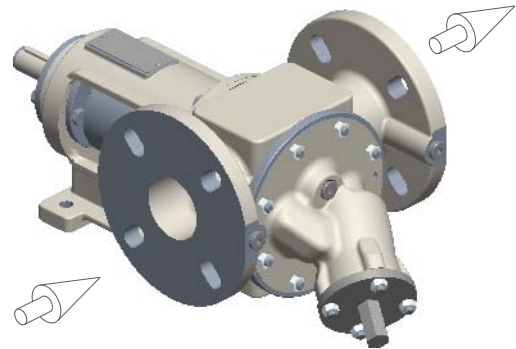

kg = 38

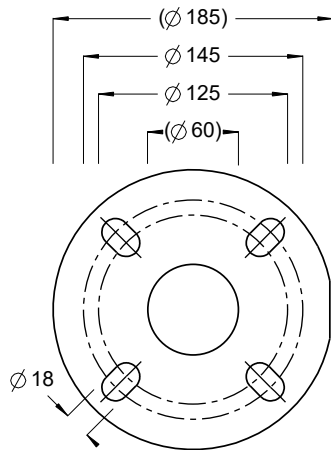
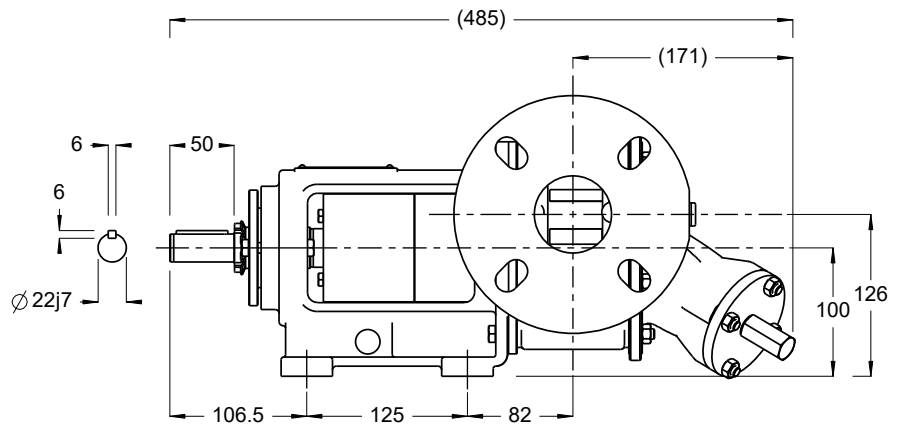
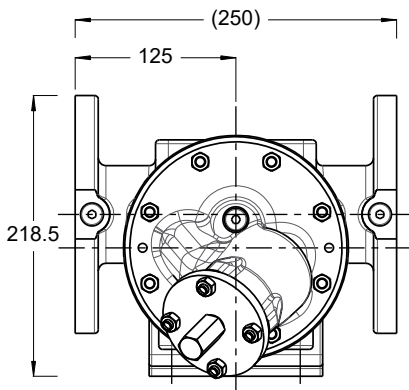

ISO DN50 PN16
ANSI 2" 150lb

