

R 40 K..BF+Y

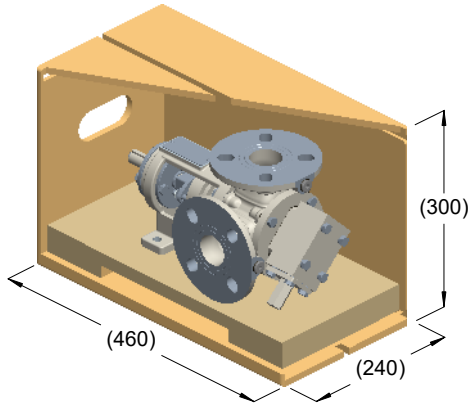

kg = 21
m³ = 0.05

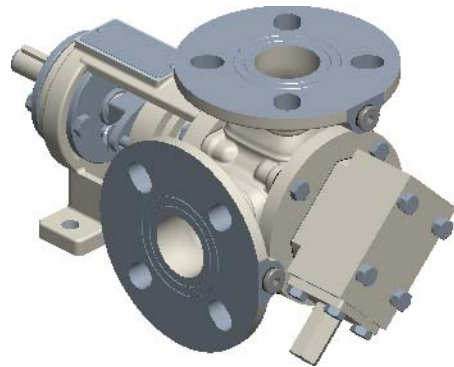

kg = 18

