

R 40 ...BF+Y

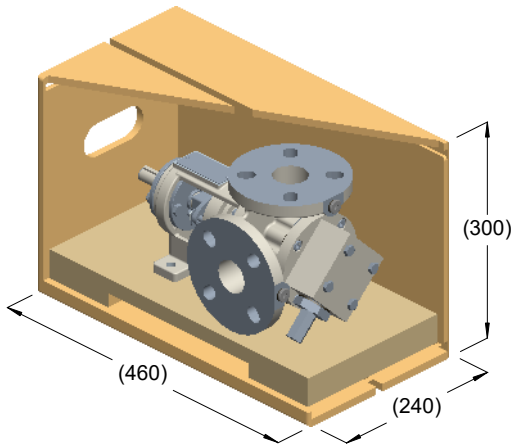

kg = 23
m³ = 0.05

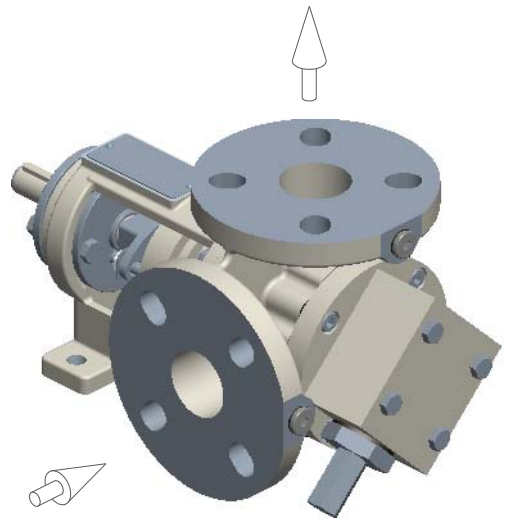

kg = 20

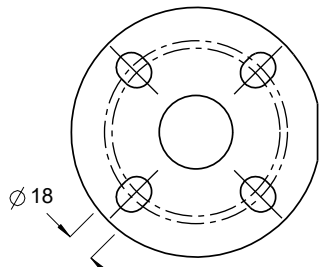
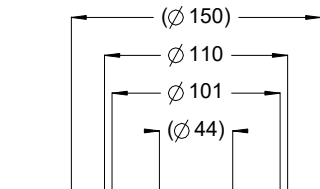
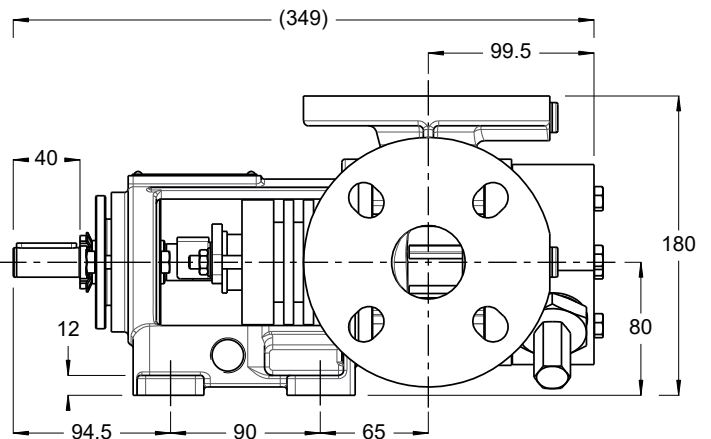
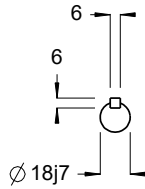
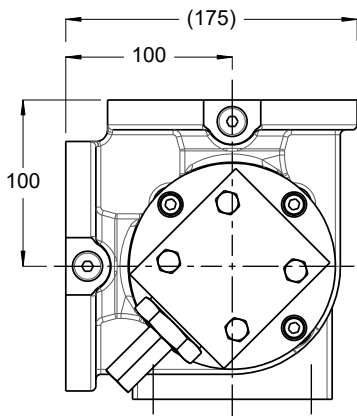

ISO DN40 PN16
ANSI 1/2" 150lb

