

**R 35 K..M+Y**

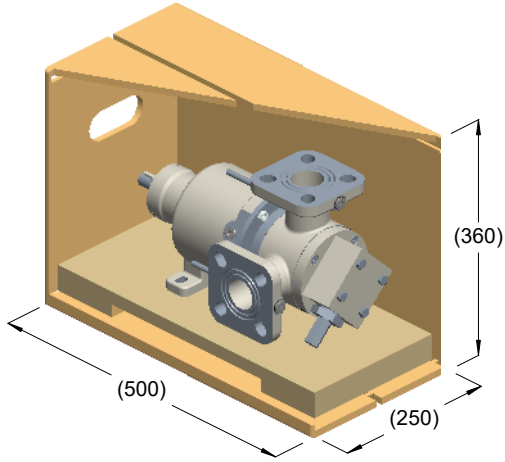

kg = 34  
m<sup>3</sup> = 0.05

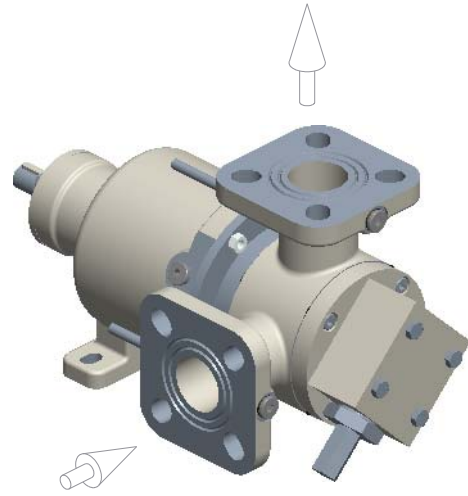

kg = 31

