

R151 ...B+Y

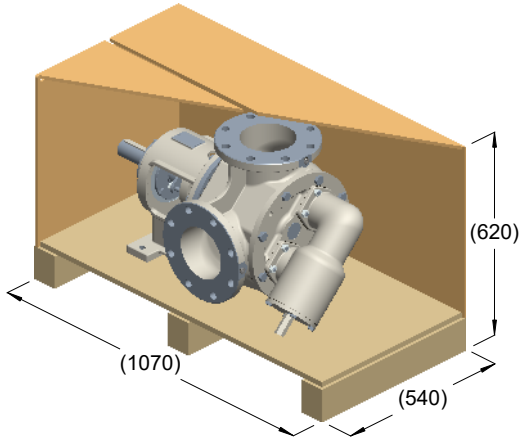

kg = 235
m³ = 0.36

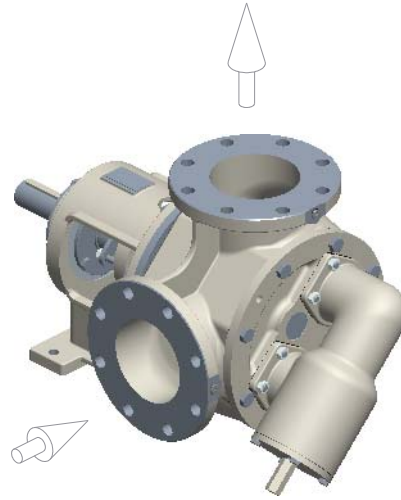

kg = 222

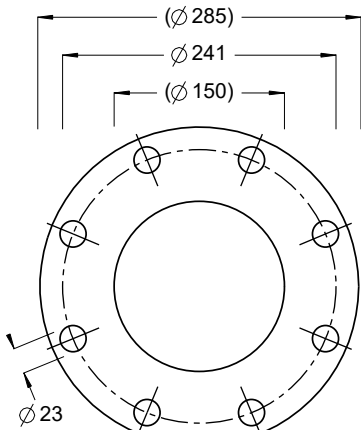
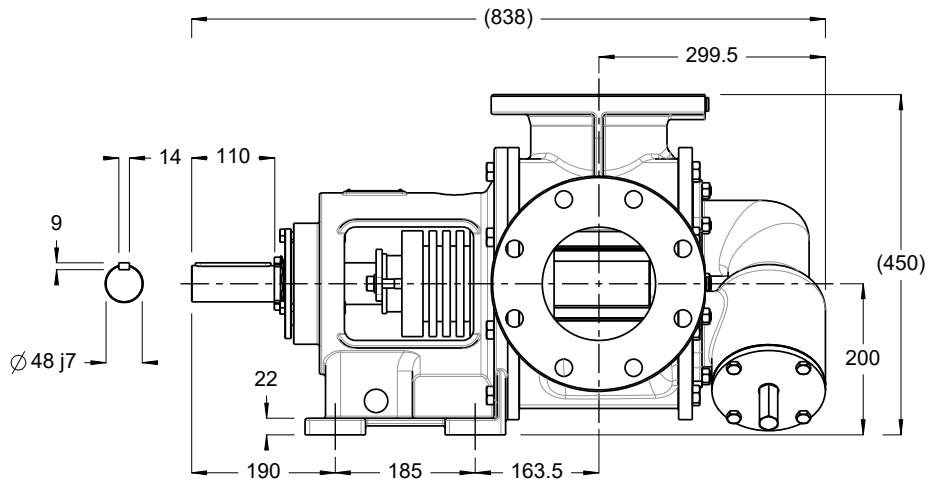
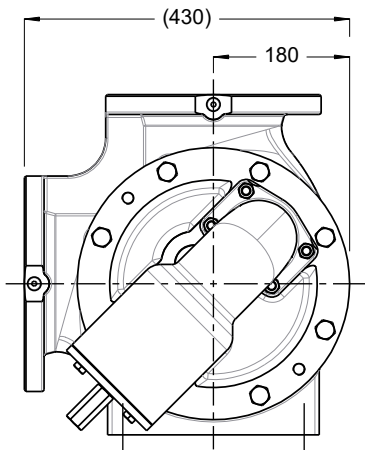

ISO DN150 PN16
ANSI 6" 150lb

