

R105 .L.B+Y

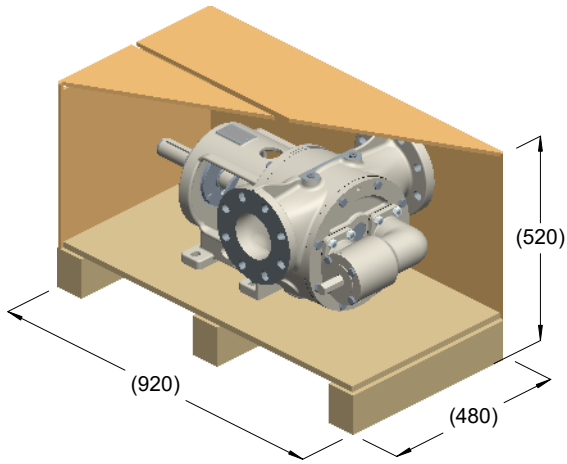

kg = 164
m³ = 0.27



kg = 156

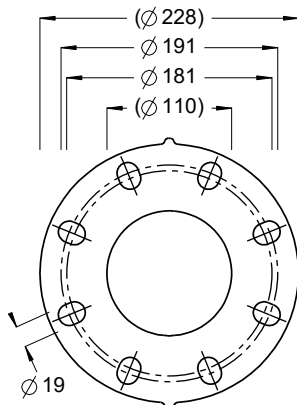
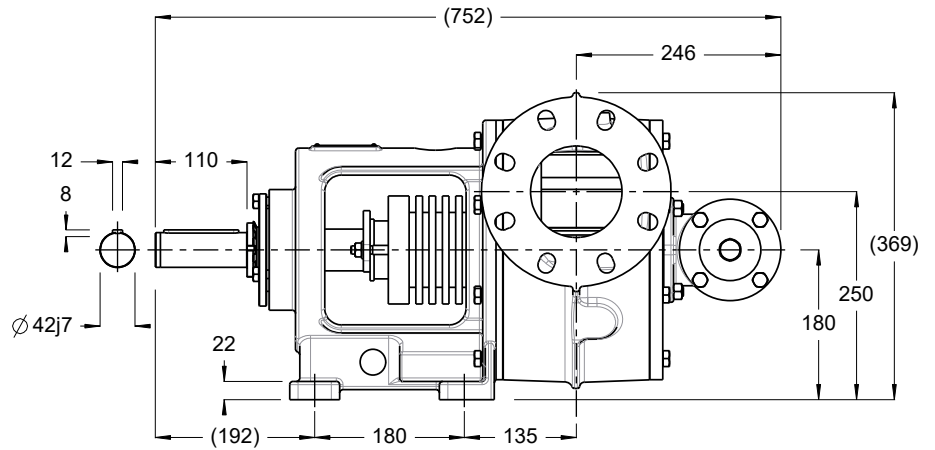
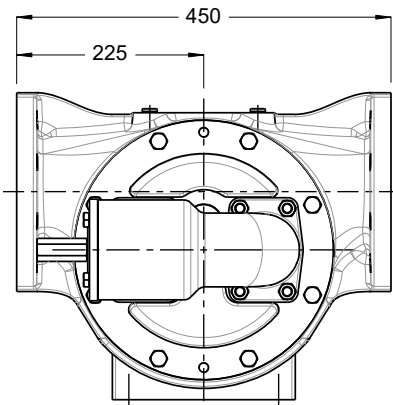

ISO DN100 PN16
ANSI 4" 150lb

