

R 50 .L.B+Y

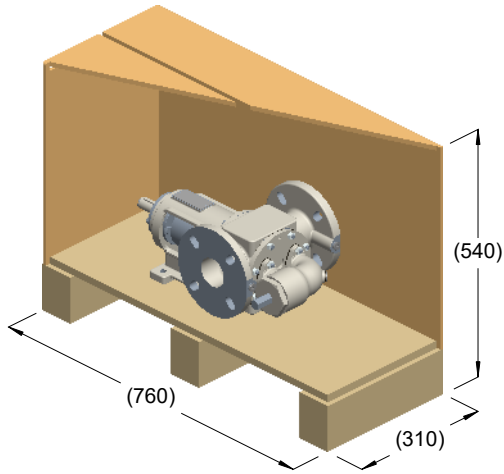

kg = 43
m³ = 0.13

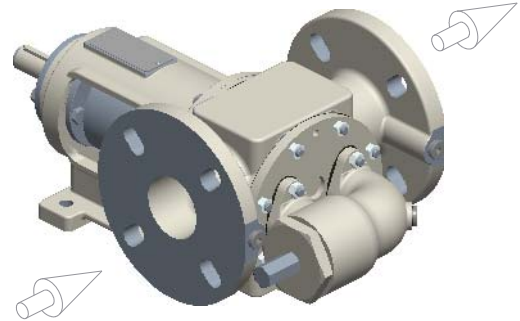

kg = 37

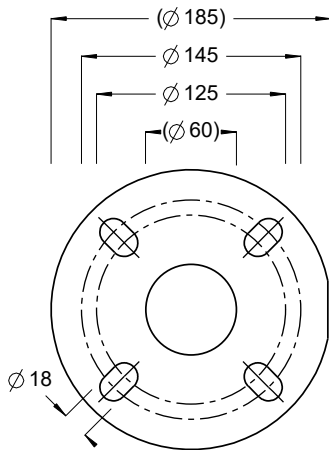
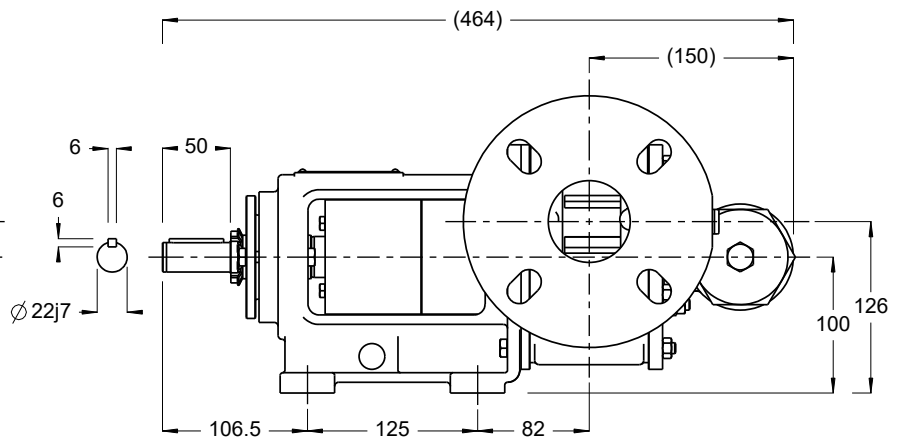
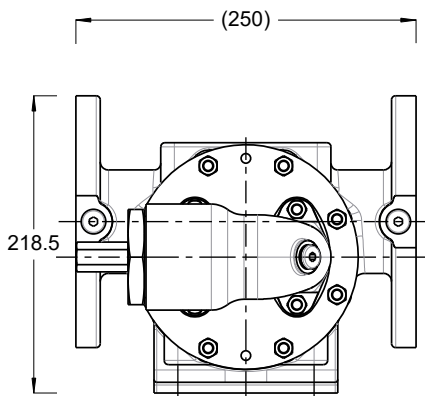

ISO DN50 PN16
ANSI 2" 150lb

